

De Z-102V encoder is compact en universeel toepasbaar.





Universeel vanwege zijn instelbare resolutie van 48 tot 2048 pulsen/omw* en standaard meegeleverde montage platen en as adapters.



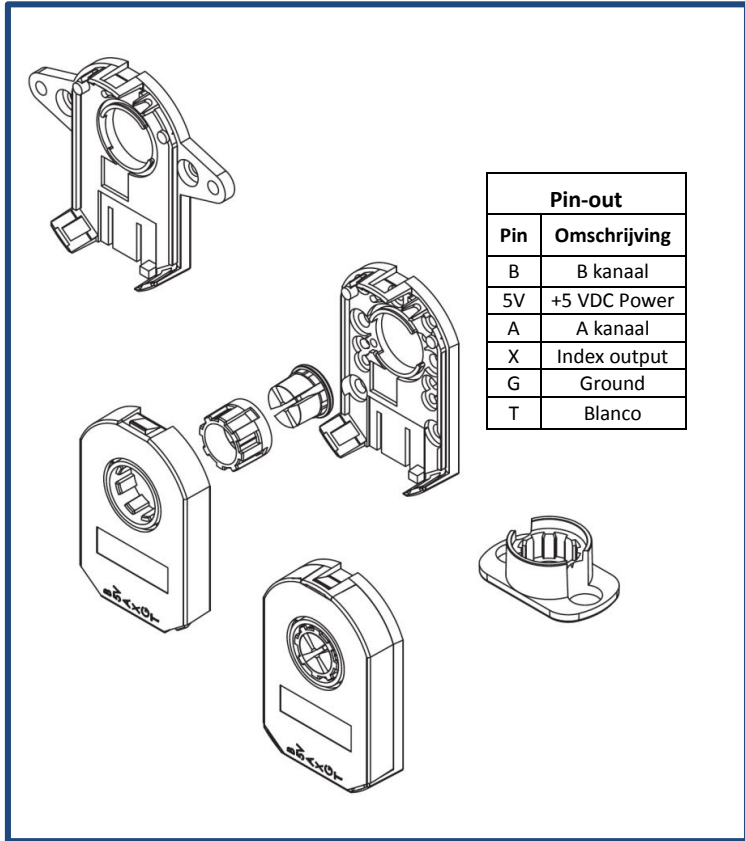

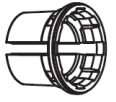
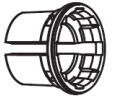
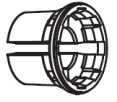

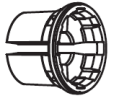
Standaard uitgangen: A, B & index.

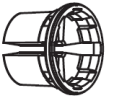
* zie overzicht 'resolutie instellingen'

Specificaties



As Adapters								
								
8mm	1/4 inch (6.35mm)	6mm	5mm	3/16 inch (4.76mm)	4mm	1/8 inch (3.175mm)	3mm	2mm
Blauw	Wit	Rood	Groen	Geel	Grijs	Paars	Oranje	Licht blauw

Montagetool A	Montagetool B	Montageplaat	Montageplaat Breed	Encoderkap	As adapter
					

Afmetingen

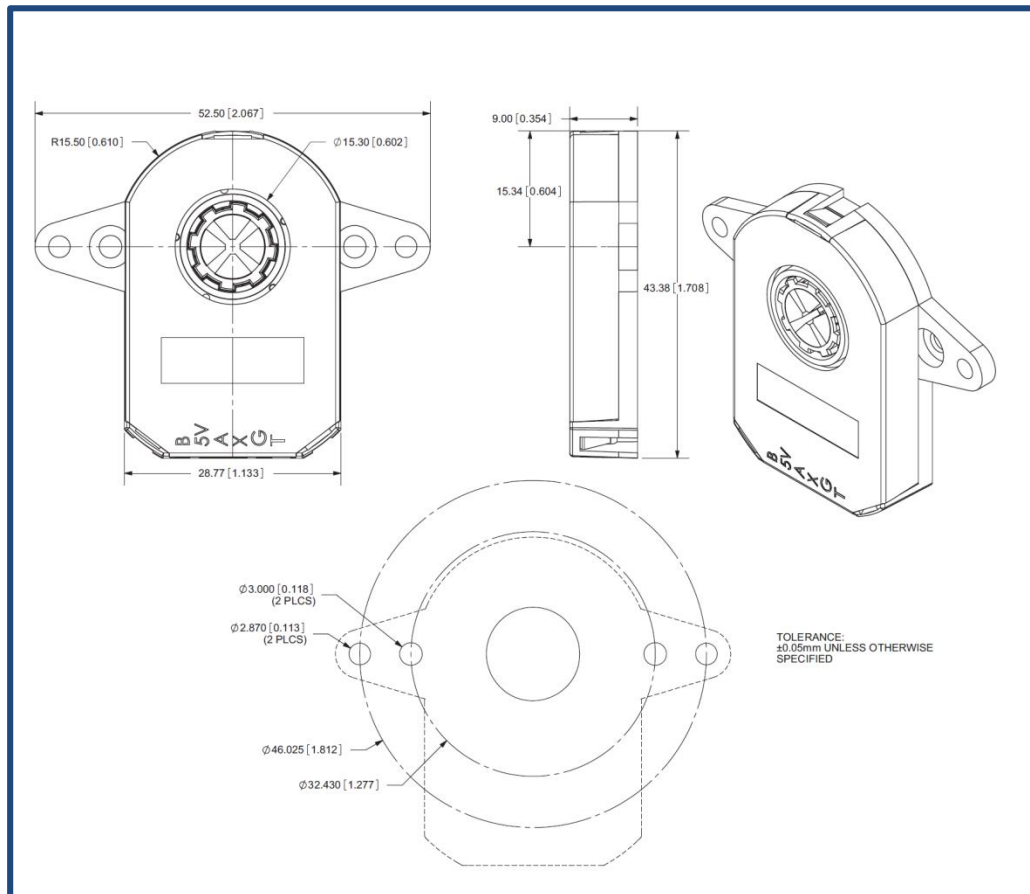
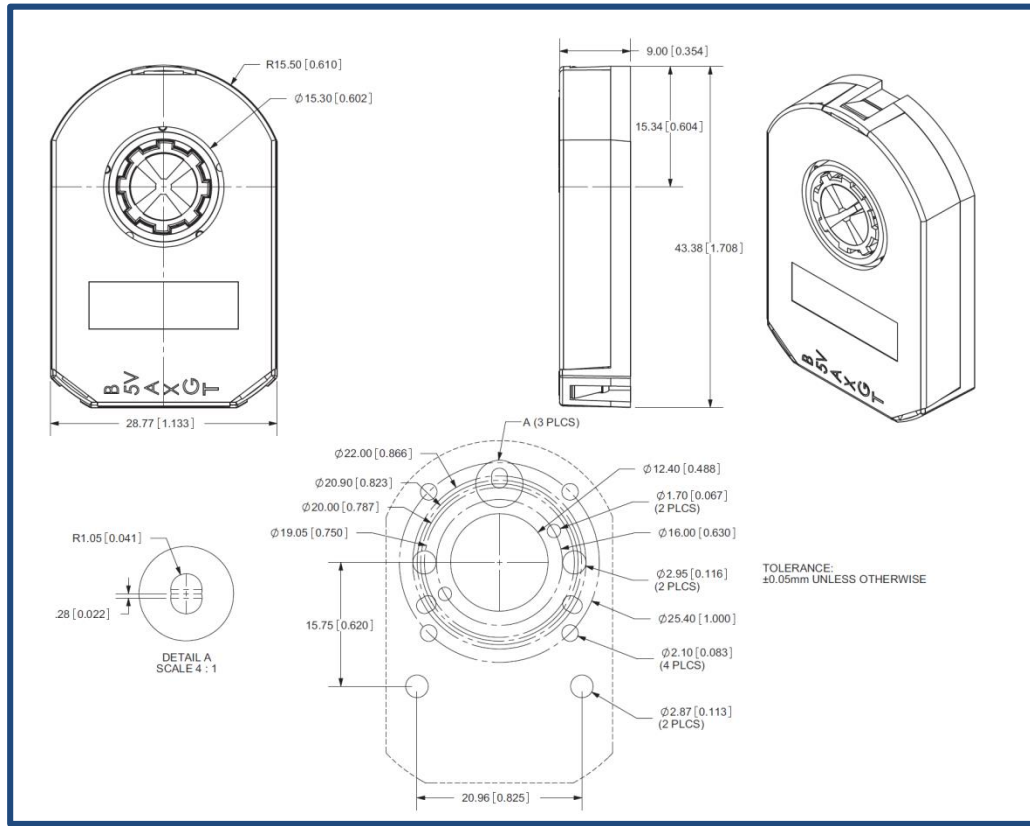

Resolutie instellingen

0 = On, 1 = Off

Resolution [PPR]	Maximum RPM	4	3	2	1
2048	7500	1	1	1	1
1024	7500	1	0	1	1
1000	7500	1	1	1	0
800	7500	1	1	0	1
512	15000	0	1	1	1
500	7500	1	0	1	0
400	7500	1	0	0	1
384	7500	1	1	0	0
256	15000	0	0	1	1
250	15000	0	1	1	0
200	15000	0	1	0	1
192	7500	1	0	0	0
125	15000	0	0	1	0
100	15000	0	0	0	1
96	15000	0	1	0	0
48	15000	0	0	0	0

DIP switch:
Example setting: 500

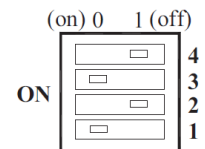

(PPR) Pulsen per omwenteling.

Assemblage procedure

Stap 1

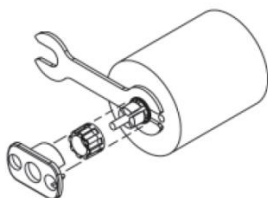

Stap 2

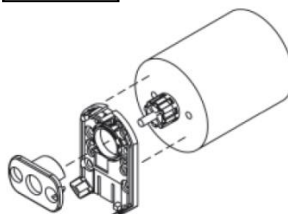

Stap 3

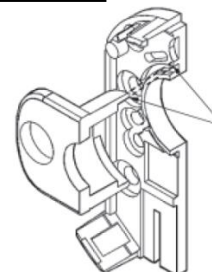

Stap 4

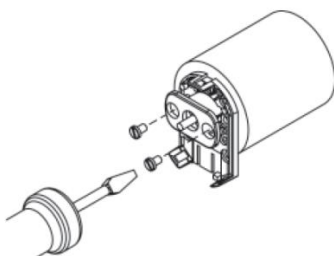

Stap 5

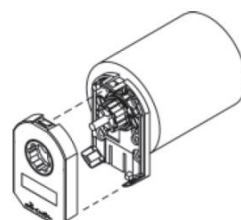

Stap 6

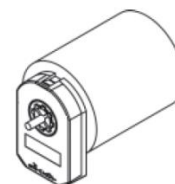

Aansluitkabels

Optioneel zijn er diverse standaard aansluitkabels leverbaar.

1. **Standaard kabel**, geconfectioneerde met connector, lengte 1.8 mtr kabel, ader diameter AWG24.
Ons artikel: 4000471

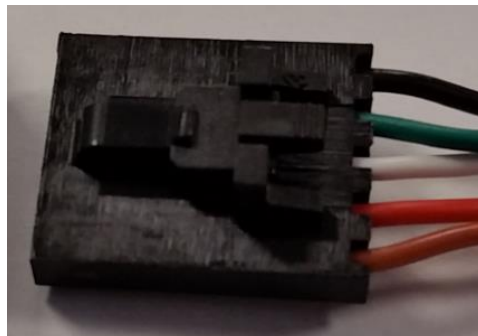
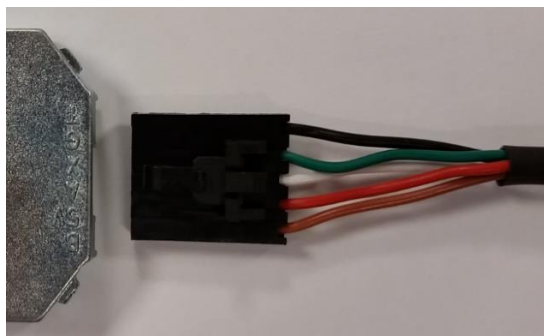

Let Op!!

Monteer de connector op de juiste wijze. De positionering van het Lock mechaniek volgens bovenstaande afbeeldingen.

2. **Line driver kabel**, geconfectioneerde met connector, lengte 1.0 mtr kabel, ader diameter AWG24.
Ons artikel: 6000228

CABLE COLOR	BROWN	WHITE blue	BLUE	WHITE orange	ORANGE	WHITE brown	WHITE green	GREEN
OUTPUT TYPE	GND	\bar{X}	X	\bar{A}	A	5V	\bar{B}	B
CABLE COLOR	BROWN (1)	PURPLE (2)	BLUE (3)	ORANGE (4)	YELLOW (5)	-	-	-
OUTPUT TYPE	GND	X	A	5V	B			

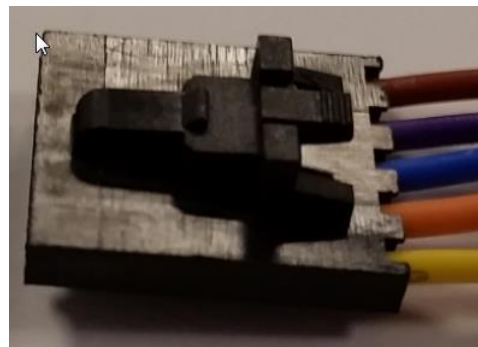
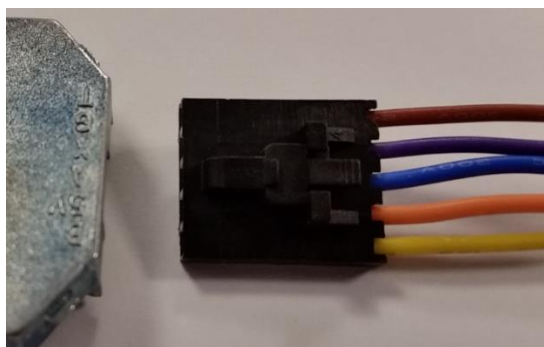

Let Op!!

Monteer de connector op de juiste wijze. De positionering van het Lock mechaniek volgens bovenstaande afbeeldingen.