

637.005 DCGM 77 T72

DC-MOTOR WITH WORM GEAR

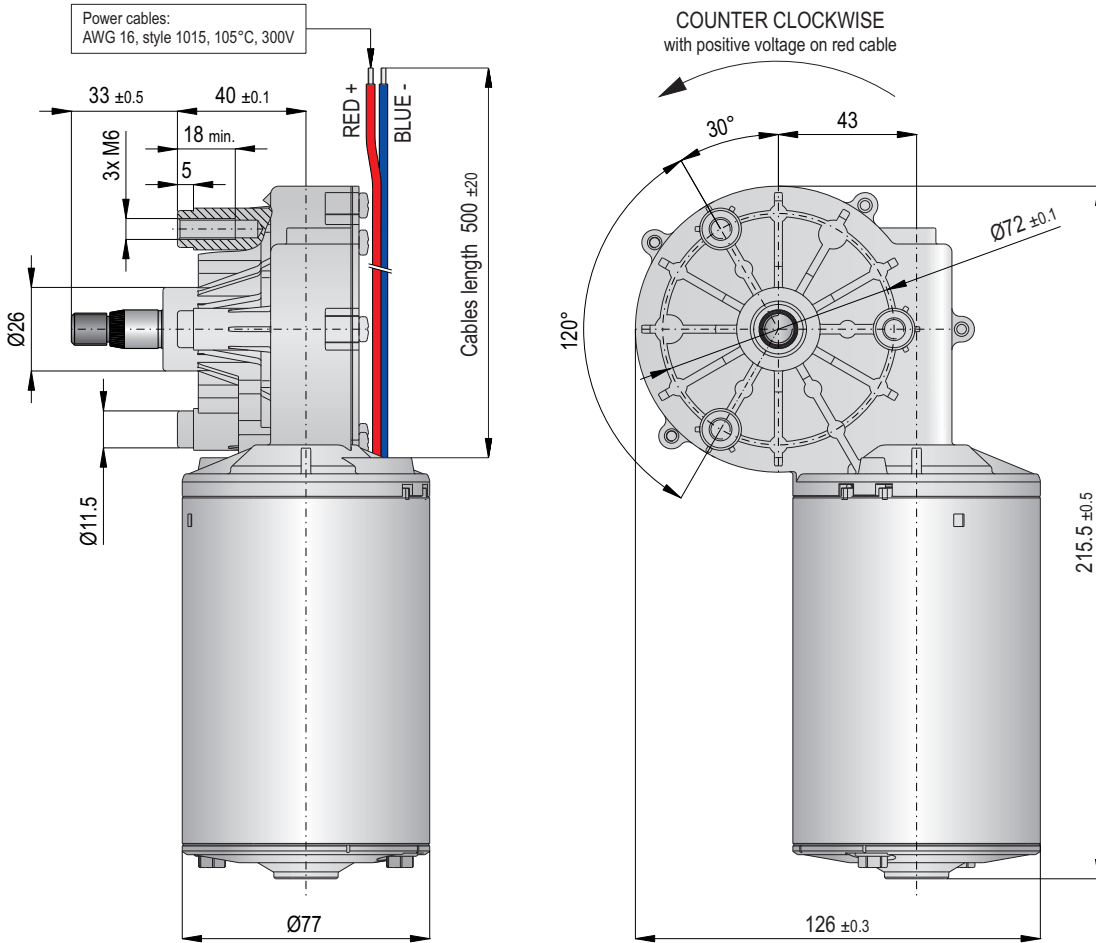

Ø 77 mm



24 V/DC



50 min⁻¹



60 Nm



0,47 µF
16,0 µH



-

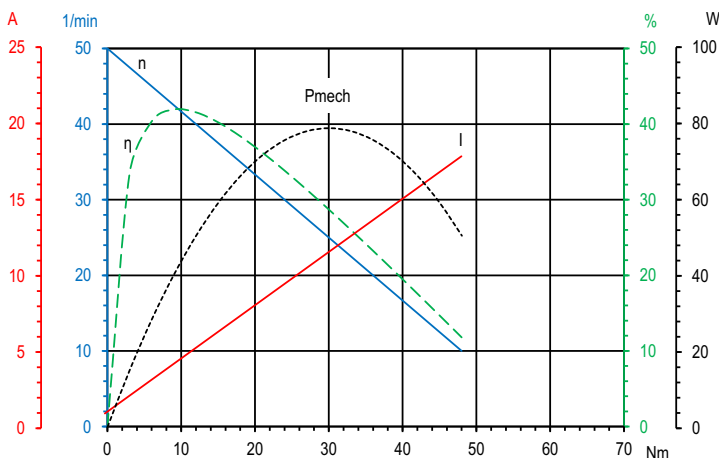
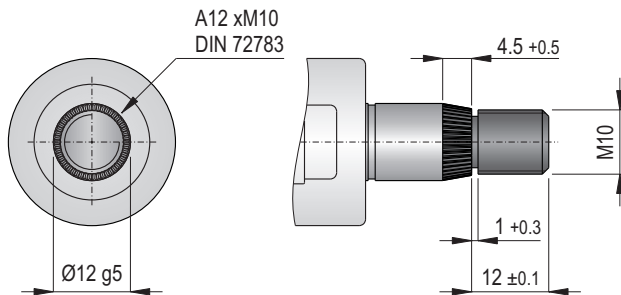

Diese Angaben sind Mittelwerte gemessen im kalten Zustand des Motors. Abweichungen von ±10% sind möglich. Technische Änderungen vorbehalten.
These data are measured average values at cold engine. Deviations from ±10% are possible. Subject to change without notice.

Technische Daten / Technical data

| | |
|----------------------------------|-----------------------------|
| Nennspannung / Nominal voltage | 24 V/DC |
| Leerlaufdrehzahl / No-load speed | 50 min⁻¹ |
| Nenn Drehmoment / Nom. torque | 10 Nm |
| Anlaufmoment / Starting torque | 60 Nm |
| Hall-Sensor / Hall sensor | - |
| Zahnradwerkstoff / Gear material | Kunststoff / Plastic |
| Übersetzung / Gear ratio | 47:1 |
| Schutzart / Protection class | IP 30 |
| Gewicht / Weight | 2,3 kg |

637.005.00.1-2019.07.03



GERDT SEEFRID GMBH • Theodor-Heuss-Straße 35 • DE-61118 Bad Vilbel-Dortelweil
Fon +49 (0)6101 5252-0 • Fax +49 (0)6101 5252-18 • vertrieb@seefrid.de • www.seefrid.com

Allgemeines

Alle Angaben zu DC-Motoren und DC-Linearantrieben sind Mittelwerte gemessen im kalten Zustand. Abweichungen von $\pm 10\%$ sind möglich. Technische Änderungen vorbehalten.

Aktuelle Informationen finden Sie auf unserer Internetseite unter www.seefrid.com.

General

All data to DC motors and DC linear actuators are measured average values at cold engine. Deviations from $\pm 10\%$ are possible. Subject to change without notice.

Current information you will find on our website www.seefrid.com.

Symbole / Symbols



Nennspannung [V]
Nominal voltage [V]



Leerlaufdrehzahl [min^{-1}]
No-load speed [rpm]



Maximalmoment [Nm]
Maximum torque [Nm]



Hubhöhe [mm]
Stroke [mm]



Leerlaufgeschwindigkeit [mm/s]
No-load speed [mm/s]



max. Hubkraft [N]
max. lift power [N]



\varnothing Motortopf [mm]
Motor diameter [mm]



Motorbefestigung [mm]
Mounting of motor [mm]



Hall-Sensor
Hall sensor



EMV Entstörung
EMC filter

Allgemeines Anschlussschema für Motoren mit eingebautem Hall-Sensor

General connection diagram for motors with built-in Hall sensor

• Anschlussschema mit 1-Kanal Hall-Sensor

Connection diagram with a 1-channel Hall sensor

• Anschlussschema mit 2-Kanal Hall-Sensor

Connection diagram with a 2-channel Hall sensor



Umrechnungen (für die Praxis gerundete Werte) / *Conversion (rounded values)*

• **Kräfte** / *Forces*

1 N = 0,1 kg = 100 g 1 kg = 10 N = 10.000 mN

• **Drehmomente** / *Torques*

1 Nm = 10.000 g/cm = 10 kg/cm 1 kg/cm = 0,1 Nm = 10 Ncm
 1 Ncm = 100 g/cm = 0,1 kg/cm 1 g/cm = 1·10⁻⁴ Nm = 1·10⁻² Ncm

Kennlinie / *Diagram*

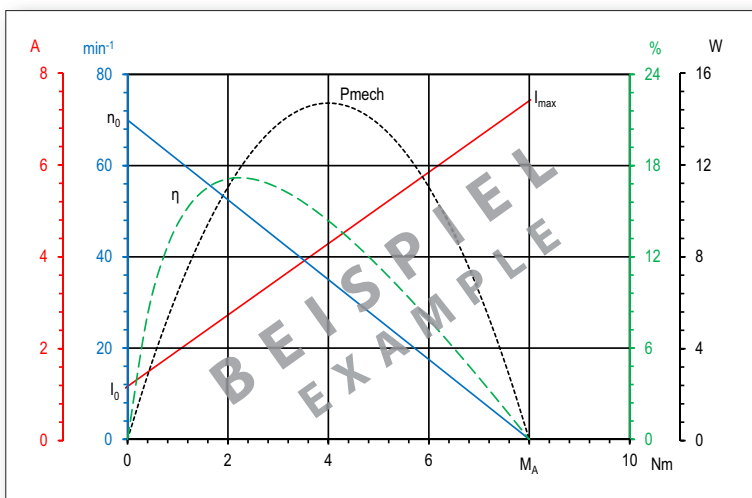

Legende / *Description*

- n_0 = Leerlaufdrehzahl / *No-load speed* [min⁻¹]
- η = Wirkungsgrad / *Efficiency* [%]
- P_{mech} = mech. Leistung / *Mech. power* [W]
- I_0 = Leerlaufstrom / *No load current* [A]
- I_{max} = Maximalstrom / *Max. current* [A]
- M = Drehmoment / *Torque* [Nm]
- M_A = Anlaufmoment / *Starting torque* [Nm]

EMV-Entstörung / *EMC filter*

Ein Teil unserer DC-Motoren und DC-Linearantriebe sind mit Entstörkomponenten ausgestattet. Hierbei handelt es sich ausschließlich um eine Grundentstörung. Die tatsächlich notwendige Entstörung ist anwendungsabhängig zu ermitteln.

Some of our DC motors and DC linear actuators have built-in EMC filter components. This is only a basic interference suppression. The really needed interference suppression must be determined in combination with the complete machine.

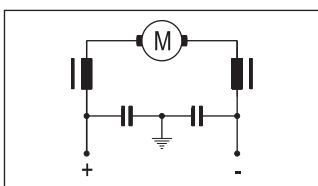

Kapazitive und induktive EMV-Entstörung. *EMC suppression with capacitor and choke.*

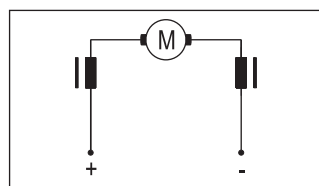

Induktive EMV-Entstörung. *EMC suppression with choke.*

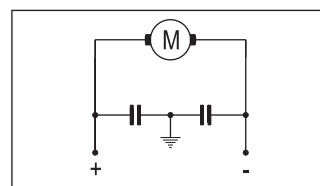

Kapazitive EMV-Entstörung. *EMC suppression with capacitor.*

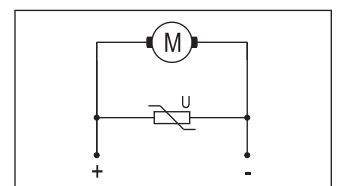

EMV-Entstörung mit einem Varistor. *EMC suppression with a varistor.*

Beispiel: / *Example:*



1,0 nF
4,7 μH

Beispiel: / *Example:*



- nF
4,7 μH

Beispiel: / *Example:*



1,0 nF
- μH

Beispiel: / *Example:*



Varistor