



RP20 Series I/O System

RP20-0016DTP

RP20-0808DTP

RP20-0016DTN

RP20-1600DT

Digital I/O Module

User Manual

Contact Us

Kinco Automation (Shanghai) Co., Ltd

Address: Building 3, No. 26, Qiuyue Road, Zhangjiang High-tech Park, Shanghai (201203)

Tel: 86-21-68798588

Fax: 86-21-68797688

Email: sales@kinco.cn

Kinco Electric (Shenzhen) Co., Ltd.

Address: 3rd Floor, Building 1, Yizhongli Industrial Park, No. 6 Langshan Road, North District, Nanshan District, Shenzhen (518057)

Tel: 86-755-26585555 (12 lines)

Fax: 86-755-26616372

Email: sales@kinco.cn

Support

If you have questions during product selection or usage, customers in China can call our technical support hotline at 400-700-5281 (Chinese service only).

For inquiries about the products described in this manual, please contact your local Kinco office or distributor. For information on user training, visit our company website or consult your local distributor for training plans.

Manual Acquisition

This manual is a paperless document. To obtain a PDF version, visit the Kinco official website (<https://en.kinco.cn/>), navigate to "Service → Download", and search by keywords to download.

Device Description File Acquisition

The RP20 series I/O modules file (.xml) integrates device descriptions for all CPU modules in the AK8X0 series or RP20 series couplers. Please visit the Kinco official website <https://www.kinco.cn/> (CN), <https://en.kinco.cn/> (EN) or contact Kinco's official customer service department to obtain the latest device description files.

Reversion History

Reversion Date	Release Version	Description
2024/12/25	RP20DIO_usermanual_V000	Initial Revision

Catalogue

Contact Us	I
Support.....	I
Manual Acquisition	I
Device Description File Acquisition.....	I
Reversion History	II
Catalogue.....	III
1 Safety Instructions.....	1
2 Overview.....	5
2.1 Introduction	5
2.2 Naming Rules	5
2.3 Fuselage Label	6
3 General Specification	7
4 Product List	8
5 Component Description	8
6 Technical Specification	10
6.1 RP20-0016DTP	10
6.2 RP20-0016DTN.....	11
6.3 RP20-1600DT	11
6.4 RP20-0808DTP	12
7 Wiring	14
7.1 RP20-0016DTP	14
7.2 RP20-0016DTN.....	14
7.3 RP20-1600DT	15
7.4 RP20-0808DTP	15
8 Dimensions	16
9 Assembly Instructions	17
9.1 Assembly Dimensions	17
9.2 Assembly Method.....	17
9.2.1 DIN Rail Dimensions	17
9.2.2 Module Assembly.....	18
9.2.2 Connector Assembly.....	21
10 Getting Start.....	23
10.1 Device Description File Acquisition.....	23
10.2 Install Device Description File.....	23
10.2.1 When Used with RP20 Coupler	23
10.2.2 When used with AK840M Controller	28
11 Error Diagnostics	32

1 Safety Instructions



This chapter outlines safety precautions for proper use of the product. Before use, read this manual and any related documentation to understand the safety instructions. Failure to follow these precautions may result in death, serious injury, or equipment damage.

The "Danger," "Warning," and "Caution" notes in this manual are not exhaustive but supplement general safety measures.

Use this product within its design specifications to avoid malfunctions. Damage or issues caused by non-compliance are not covered under warranty.

Kinco assumes no legal responsibility for personal injury, property damage, or other accidents resulting from non-compliance with this manual or improper operation of the product.

To ensure safe use, this manual employs specific symbols and graphical markings to highlight important safety-related information. Please adhere strictly to these precautions.

	<p>Danger/Prohibited Indicates prohibited actions. If proper precautions are not taken, it may result in serious personal injury or even death.</p>
	<p>Warning Indicates cautionary actions. If proper precautions are not taken, it may result in serious personal injury or even death.</p>
	<p>Caution Indicates general information or directives. If the corresponding precautions are not followed, it may lead to unintended results.</p>

During power supply



- ❖ During power supply, do not touch terminals or attempt disassembly. Wait for capacitors to discharge after turning off the power to avoid electric shock or hazards.

During electrical assembly



- ❖ Installation, wiring, maintenance, and inspection must be performed by qualified personnel trained in electrical equipment.
- ❖ Avoid dusty, corrosive, or high-temperature environments.



- ❖ When processing screw holes or wiring, take care to prevent metal shavings, dust, and wire fragments from entering the controller's ventilation channels, as this may cause fire, malfunctions, or other unintended operations.

During wiring



- ❖ The installation, wiring, maintenance, and inspection of this product must be carried out by professional electrical maintenance personnel who have received relevant training in electrical equipment and possess sufficient electrical knowledge.
- ❖ Wiring work must only be performed after ensuring that the external power supply to the system is completely disconnected. Otherwise, there is a risk of electric shock, equipment failure, or unintended operation.



- ❖ After completing installation and wiring, ensure the product is fully assembled (including end caps and cover plates) before powering on and operating; otherwise, there is a risk of electric shock.
- ❖ Cable terminals must be properly insulated, and the insulation distance between cables should not decrease after installation on the terminal block. Failure to do so may result in electric shock, short circuit, or equipment damage.



- ❖ When processing screw holes or wiring, take care to prevent metal shavings, dust, and wire fragments from entering the controller's ventilation channels, as this may cause fire, malfunctions, or unintended operations.
- ❖ Before connecting cables, confirm the type of interface being connected. Incorrect interface connections or wiring errors may result in controller or external equipment malfunctions or damage.
- ❖ Tighten the bolts on the terminal block within the specified torque range. Failure to tighten them properly may result in circuit short circuits, loose connections, or fire hazards. Over-tightening could damage the bolts or the controller, causing component detachment, circuit short circuits, or fire hazards.
- ❖ When connecting external devices via connectors, use tools specified by the

manufacturer for proper crimping, pressing, or soldering. Poor connections may lead to short circuits, fire, or unintended operations.

- ❖ Do not bundle control lines or communication cables with main circuit or power supply lines, nor place them too close to each other. Ensure control and communication cables are arranged at least 100 mm apart from main circuit power lines in separate cable ducts or spaces to prevent noise-induced malfunctions.
- ❖ For applications with severe interference, use specialized shielded cables for high-frequency signal input or output to enhance the system's anti-interference capability.

During system design and debugging



- ❖ Always design a safety circuit to ensure that the control system remains secure in the event of an external power failure or controller malfunction.
- ❖ If the output circuit experiences prolonged overcurrent due to exceeding the rated load current or a short circuit in the load, the controller may emit smoke or catch fire. Install external fuses or circuit breakers as safety protection devices.



- ❖ Ensure that the external circuit of the controller includes an emergency brake circuit, protection circuit, interlock circuits for forward/reverse operations, and upper/lower limit interlock switches to prevent machine damage.
- ❖ To ensure safe equipment operation, design external protection circuits and safety mechanisms for output signals related to critical accidents.
- ❖ The controller's CPU may automatically disable all output signals when detecting a system abnormality. If part of the controller's circuitry malfunctions, outputs may become uncontrollable. To ensure proper operation of the equipment, design appropriate external control circuits.
- ❖ If the controller's transistor output unit is damaged, its output state may become uncontrollable.
- ❖ Programmable Logic controllers (PLCs) are designed for indoor use in electrical environments with overvoltage category II. The power supply system should include lightning protection devices to prevent overvoltage caused by lightning from affecting the power input, signal input, or control output ports of the controller, thus avoiding equipment damage.

During operation and maintenance



- ❖ The installation, wiring, maintenance, and inspection of this product must be carried out by professional electrical maintenance personnel who have received relevant training in electrical equipment and possess sufficient electrical knowledge.
- ❖ Before cleaning or re-tightening the bolts on the terminal block or the connector installation bolts, please ensure that the system's power supply is completely disconnected.



❖ During equipment debugging, thoroughly read the user manual before performing operations such as online program modifications, forced outputs, start (RUN), and stop (STOP). Ensure that the safety of these operations is fully confirmed before proceeding.

2 Overview

To explore diverse automation application scenarios and providing customers with more comprehensive automation solutions, Kinco has launched the Kinco-RP20 series bus-based I/O system.

2.1 Introduction

The RP20 series products, with their robust industrial design and manufacturing quality, outstanding performance, and comprehensive feature integration, are not only widely applicable in the field of general industrial automation but also highly suitable for various specialized smart sectors such as building automation, agricultural intelligence, energy monitoring, and energy management. They are designed to offer customers versatile and flexible solution possibilities.

2.2 Naming Rules

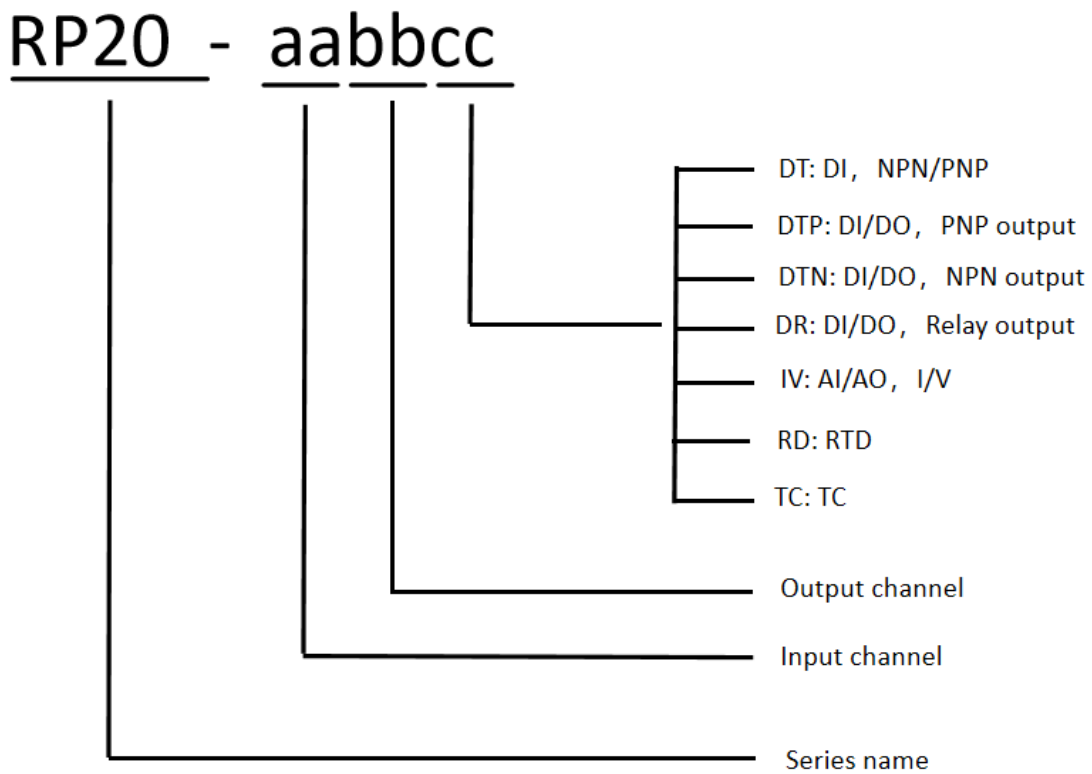

Fig. 2.2-1 RP20 series naming rules

According to the naming rules, the functionality of I/O modules can be inferred from their model numbers. For example:

- **RP20-0016DTP**: A 16-channel digital transistor output module with PNP output.
- **RP20-0016DTN**: A 16-channel digital transistor output module with NPN output.

- **RP20-1600DT**: A 16-channel digital input module supporting both sourcing and sinking types.



Note: The simplified naming rules may not fully describe the characteristics of the products. For instance, the digital hybrid module RP20-0808DTP has 8 transistor digital outputs (PNP type) and 8 digital inputs (supporting only sourcing input). Therefore, when selecting mixed modules, it is recommended to refer to the detailed product specifications.

2.3 Fuselage Label

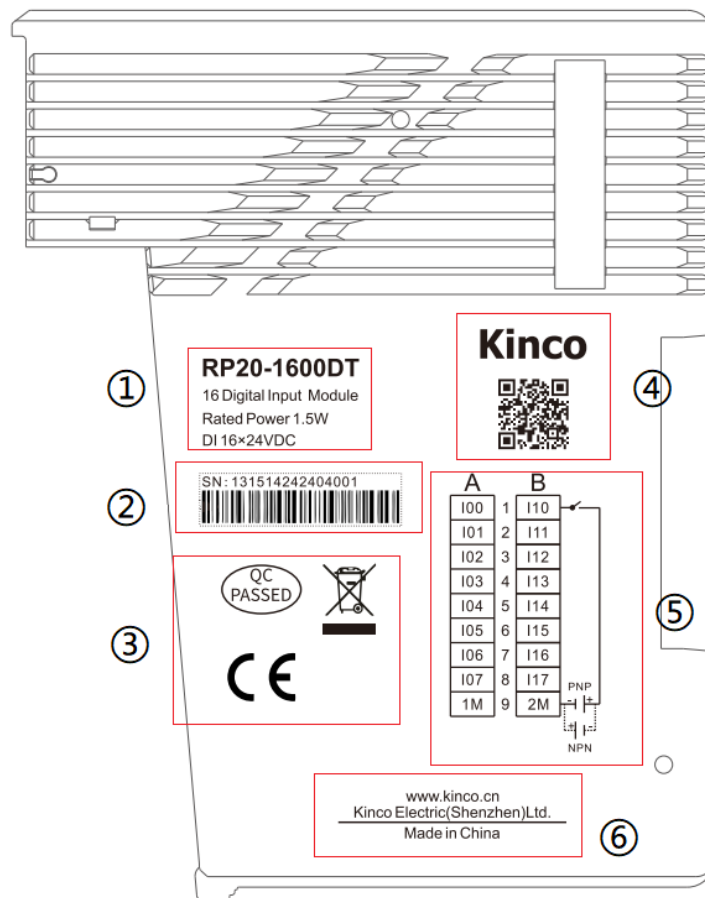

Fig.2.3-3 A sample of naming description

No.	Item	Description
①	Model and Brief Description	Includes basic information such as product model, power supply, and function description.
②	Product Serial Number	Unique and traceable.
③	Certification	Includes the product's certification standards.
④	Kinco official QR	Scan the code to directly access Kinco's official

	Code	website for more information.
⑤	I/O Wiring Diagram	Provides a clear view of wiring information.
⑥	Kinco official website	Enter the website address to visit Kinco's official website for more information.

3 General Specification

Transportation and Storage Conditions		
Climatic Conditions	Ambient Temperature	-40°C ~ +70°C
	Relative Humidity	10% ~ 95%, no condensation
	Atmospheric Pressure	Equivalent to 0-3000 meters above sea level.
Mechanical Conditions	Free Fall	With transport packaging, allows 5 drops from 1m height to the cement floor.
Operating Conditions		
Climatic Conditions	Ambient Temperature	Open device with natural ventilation, ambient temperature range: -20°C ~ 55°C.
	Relative Humidity	10% ~ 95%, no condensation
	Atmospheric Pressure	Altitude ≤ 2000 meters
	Pollution Level	Suitable for pollution level 2
Mechanical Conditions	Sine Vibration	5 < f < 8.4 Hz, Random: 3.5mm displacement; Continuous: 1.75mm displacement.
		8.4 < f < 150 Hz, Random: 1.0g acceleration; Continuous: 0.5g acceleration
	Shock	Half sine wave, 15g, 11ms, 6 times per axis.
Electromagnetic Compatibility	EMC Immunity Level	Zone B, IEC61131-2
	Electrostatic Discharge	Air discharge 8kV, contact discharge 4kV.
		Performance Level A
	Surge	DC power supply 0.5kV CM, 0.5kV DM.
I/O and communication ports: 1kV CM.		

		Performance Level A
	Fast Transient Burst	Power coupling: 2kV, 5kHz. I/O and communication coupling: 1kV, 5kHz.
		Performance Level A
Protection Level		IP20
Cooling Type		Natural air cooling
Installation Type		DIN35 rail mounting

4 Product List

Order Number	Description
RP20-0016DTP	DO 16*24V DC, PNP
RP20-0016DTN	DO 16*24V DC, NPN
RP20-1600DT	DI 16*24V DC(sourcing/sinking)
RP20-0808DTP	DI 8*24V DC(sourcing), DO 8*24V DC, PNP;
*RP20-0008DR	DO 8*Relay

5 Component Description

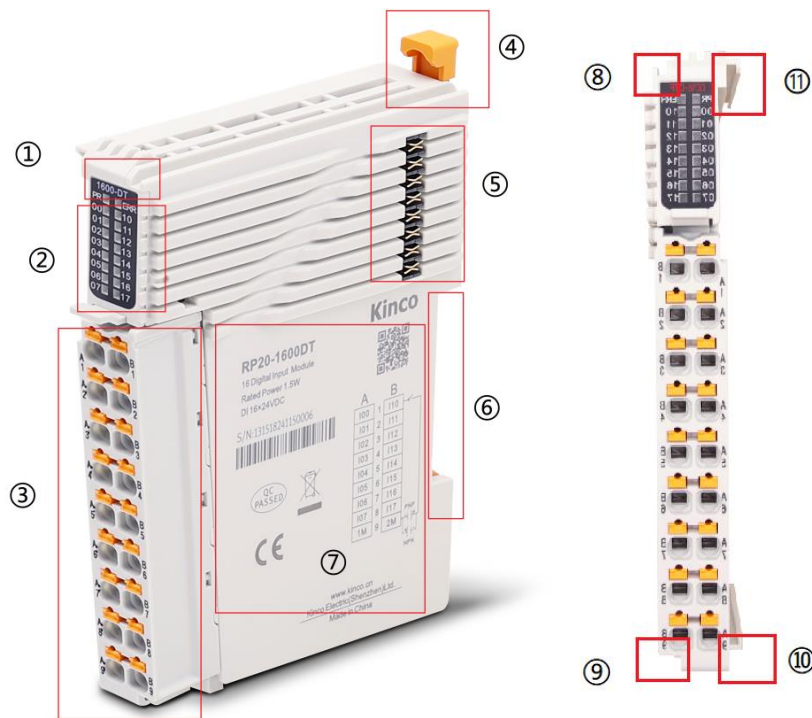













Fig.5.1-1 Component description

No.	Item	Comment			
①	Color Label	Indicate the type of the module	Refer to Chapter 2.2 Meaning:  Orange, Coupler  Red, Digital Output Module  Blue, Digital Input Module  Purple, Mixed DI/O Module		
②	Indicator Lights	 PR: Operating Status	Steady On: Normal operating state Fast Blinking (50ms / 50ms): Error event Slow Blinking (200ms / 200ms): Uninitialized ID Single Blink (200ms / 1000ms): Stopped state Double Blink (200ms / 200ms / 1000ms): Safe operating state		
		 Err: Error State	Steady On: An internal error has occurred, refer to Chapter 11 for error diagnosis. Off: No internal error has occurred.		
		 DI/DO Indicators	<table border="1"> <tr> <td data-bbox="726 925 965 1261">  00-07 (2 Groups): Indicate the channel operating status of DI/O mixed modules. </td> <td data-bbox="965 925 1342 1261"> For hybrid digital modules, there are two groups of 16 channel indicator lights (corresponding to A/B group terminals), each indicating the operating status of the respective I/O channels. </td> </tr> <tr> <td data-bbox="726 1261 965 1675">  00-17 (1 Group): Indicate the channel operating status of DI or DO modules. </td> <td data-bbox="965 1261 1342 1675"> For digital input or output modules, there's one group of 16 channel indicator lights (corresponding to terminals on both sides of A/B groups), each indicating the operating status of the respective I/O channels. </td> </tr> </table>	 00-07 (2 Groups): Indicate the channel operating status of DI/O mixed modules.	For hybrid digital modules, there are two groups of 16 channel indicator lights (corresponding to A/B group terminals), each indicating the operating status of the respective I/O channels.
 00-07 (2 Groups): Indicate the channel operating status of DI/O mixed modules.	For hybrid digital modules, there are two groups of 16 channel indicator lights (corresponding to A/B group terminals), each indicating the operating status of the respective I/O channels.				
 00-17 (1 Group): Indicate the channel operating status of DI or DO modules.	For digital input or output modules, there's one group of 16 channel indicator lights (corresponding to terminals on both sides of A/B groups), each indicating the operating status of the respective I/O channels.				
③	I/O Connector	Plug-In Spring Terminals: Tool-free installation and efficient connections. For details, refer to specific model connection diagrams.			
④	Locking Latch	Compatible with standard DIN35 rails for assembly.			
⑤	Side Connectors	Used for backplane (expansion) communication and power supply.			
⑥	DIN Rail	Standard DIN35 rail installation.			

	Slot	
⑦	Fuselage Label	Includes basic product information such as model number, serial number, certifications, and wiring diagrams. Refer to Chapter 2.3 for details.
⑧	Top Front Rail	Used for dual-side alignment when coupling modules directly, ensuring vertical alignment with the front module.
⑨	Bottom Front Rail	
⑩	Top Rear Rail	Used for dual-side alignment during module coupling, ensuring vertical alignment with the rear module.
⑪	Bottom Rear Rail	

6 Technical Specification

6.1 RP20-0016DTP

Technical Specifications	
Output Channels	16
Output type	Transistor output, PNP
Turn-On Delay	<50 μ s
Turn-Off Delay	<50 μ s
"0" Signal Level	MOSFET off
"1" Signal Level	MOSFET on
On-State Resistance	Typical: 0.15 Ω , Maximum: 0.3 Ω
Rated Output Voltage	24V DC, allowable range: 20.4V DC - 28.8V DC
Load	Resistive Load: 12A/point, 48W/module
	Inductive Load: 6W/point, 24W/module
	Lamp Load: 5W/point, 20W/module
Maximum Switching Frequency	100Hz (resistive load)
Output Leakage Current	Maximum 10 μ A
Protection	Short-circuit protection Overcurrent protection
Isolation	√
Hot Swapping	×
K-Bus Current Consumption	135mA (5V DC, room temperature)
Indicator	The corresponding LED light is on(green) when there is an output signal
Dimensions (W × H × D)	12mm × 100mm × 80mm
Weight	≈70g

6.2 RP20-0016DTN

Technical Specifications	
Output Channels	16
Output type	Transistor output, NPN
Turn-On Delay	<50 μ s
Turn-Off Delay	<50 μ s
"0" Signal Level	MOSFET off
"1" Signal Level	MOSFET on
On-State Resistance	Typical: 0.26 Ω , Maximum: 0.56 Ω
Rated Output Voltage	24V DC, allowable range: 20.4V DC - 28.8V DC
Load	Resistive Load: 12A/point, 48W/module
	Inductive Load: 6W/point, 24W/module
	Lamp Load: 5W/point, 20W/module
Maximum Switching Frequency	100Hz (resistive load)
Output Leakage Current	Maximum 10 μ A
Protection	Short-circuit protection Overcurrent protection
Isolation	√
Hot Swapping	×
K-Bus Current Consumption	135mA (5V DC, room temperature)
Indicator	The corresponding LED light is on(green)when there is an output signal
Dimensions (W × H × D)	12mm × 100mm × 80mm
Weight	≈70g

6.3 RP20-1600DT

Technical Specifications	
Input channels	16
Input type	Sourcing/Sinking
Turn-on Delay	<50 μ s
Turn-off Delay	<50 μ s
Rated Input Voltage	24V DC
Logic "0" Max. Input Voltage	5V, 0.8mA
Logic "1" Min. Input Voltage	15V, 2mA
Input Current	3.5mA @ 24V DC
Input Impedance	6.8K

Isolation	√
Hot Swapping	×
Indicator	The corresponding LED light is on(green)when there is an input signal.
Software Filtering Time Setting	√
K-Bus Current Consumption	135mA (5V DC, room temperature)
Dimensions (W × H × D)	12mm × 100mm × 80mm
Weight	≈70g

6.4 RP20-0808DTP

Digital Input Specifications	
Input channels	8
Input type	Sourcing
Turn-on Delay	<50μs
Turn-off Delay	<50μs
Rated Input Voltage	24V DC
Logic "0" Max. Input Voltage	5V, 0.8mA
Logic "1" Min. Input Voltage	15V, 2mA
Input Current	3.5mA @ 24V DC
Input Impedance	6.8K
Isolation	√
Software Filtering Time Setting	√
Indicator	The corresponding LED light is on(green)when there is an input signal.
Digital Output Specifications	
Output Channels	8
Output type	Transistor output, PNP
Turn-On Delay	<50μs
Turn-Off Delay	<50μs
"0" Signal Level	MOSFET off
"1" Signal Level	MOSFET on
On-State Resistance	Typical: 0.15Ω, Maximum: 0.3Ω
Rated Output Voltage	24V DC, allowable range: 20.4V DC - 28.8V DC

Load	Resistive Load: 12A/point, 48W/module
	Inductive Load: 6W/point, 24W/module
	Lamp Load: 5W/point, 20W/module
Maximum Switching Frequency	100Hz (resistive load)
Output Leakage Current	Maximum 10 μ A
Protection	Short-circuit protection Overcurrent protection
Isolation	√
Indicator	The corresponding LED light is on(green)when there is an output signal.
General Specification	
Hot Swapping	×
K-Bus Current Consumption	135mA (5V DC, room temperature)
Dimensions (W × H × D)	12mm × 100mm × 80mm
Weight	≈70g

7 Wiring

7.1 RP20-0016DTP

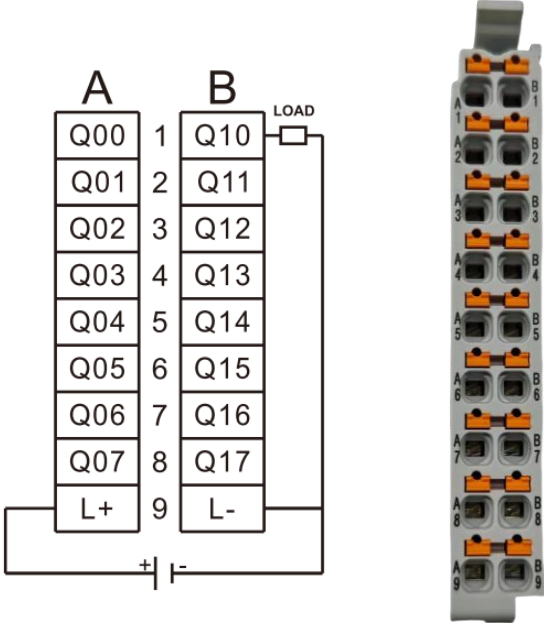

Fig.7.1-1 RP20-0016DTP wiring diagram

7.2 RP20-0016DTN

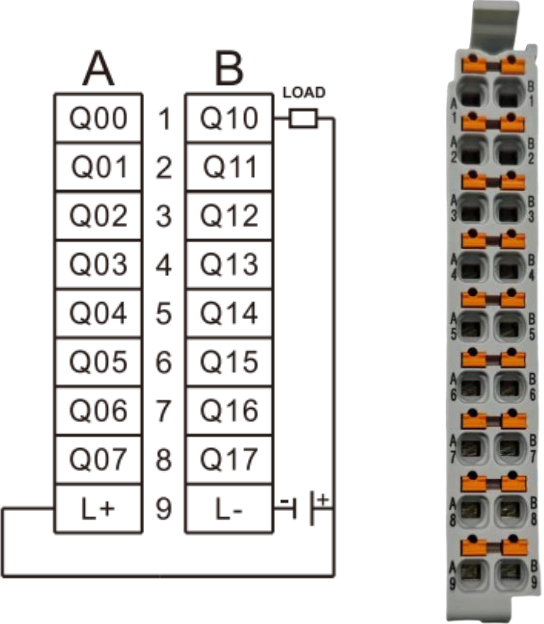

Fig.7.2-1 RP20-0016DTN wiring diagram

7.3 RP20-1600DT

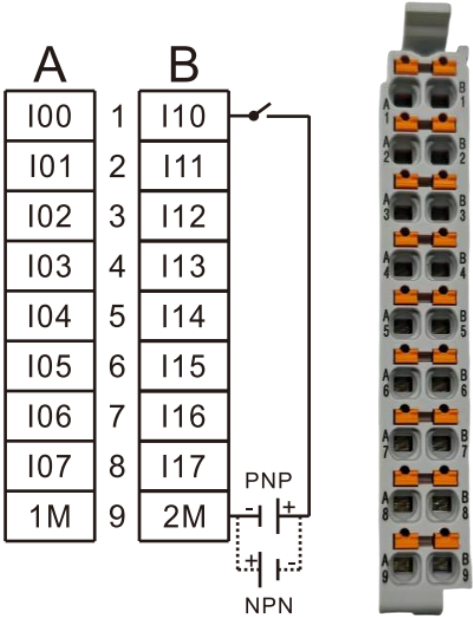

Fig.7.3-1 RP20-1600DT wiring diagram

7.4 RP20-0808DTP

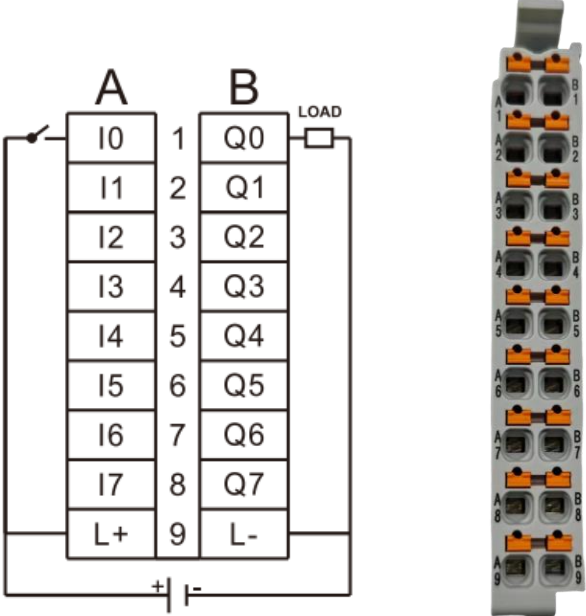
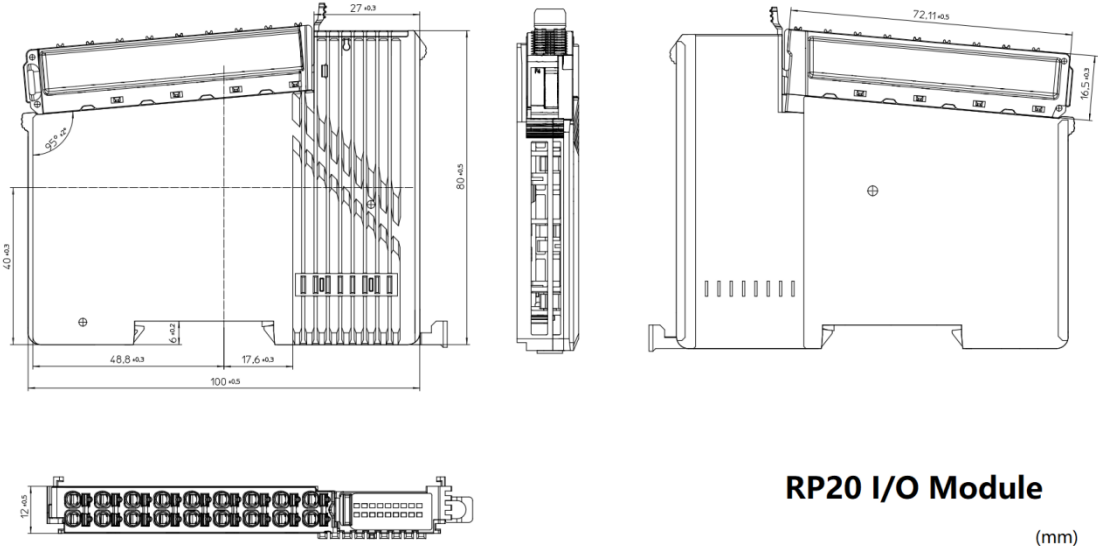

Fig.7.4-1 RP20-0808DTP wiring diagram

8 Dimensions



RP20 I/O Module

(mm)

Fig.8.1-1 Dimensional drawing

The dimensions of the above product are applicable to the following models:
RP20-0016DTP, RP20-0016DTN, RP20-0808DTP and RP20-1600DT.

9 Assembly Instructions

9.1 Assembly Dimensions

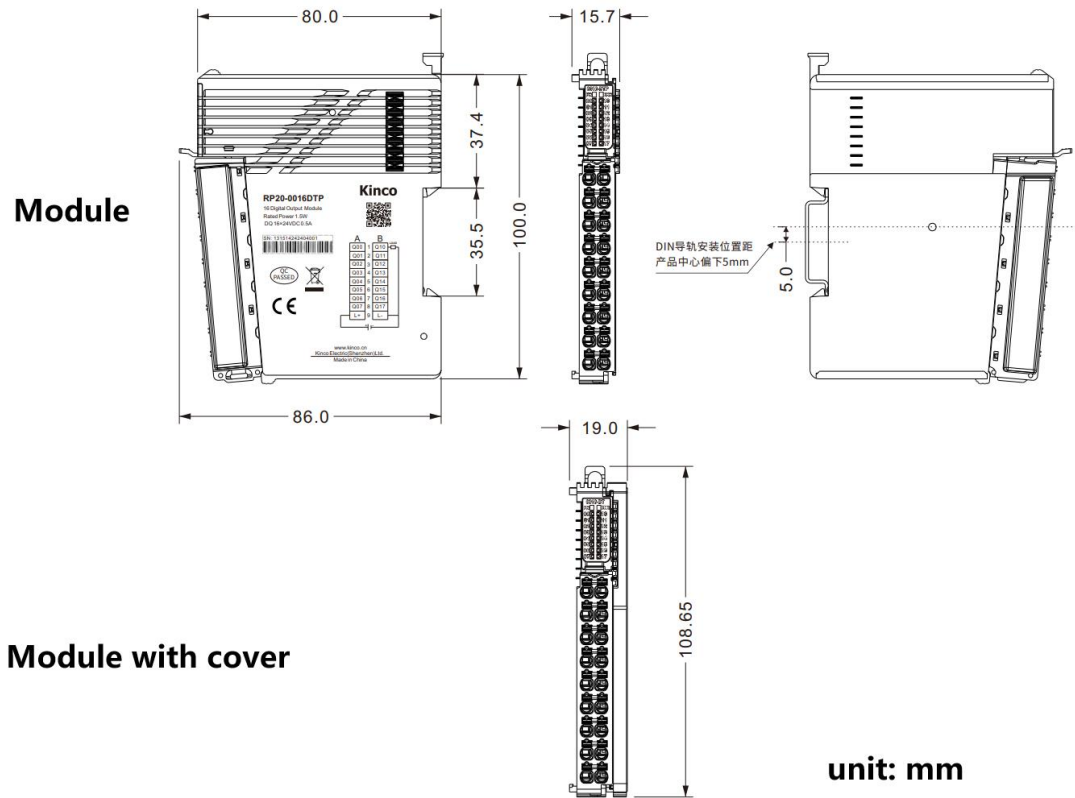

Fig.9.1-1 Assembly dimension drawing

The above assembly dimensions are applicable to the following models:
RP20-0016DTP, RP20-0016DTN, RP20-0808DTP and RP20-1600DT.

9.2 Assembly Method

9.2.1 DIN Rail Dimensions

It is recommended to use a standard 35mm wide, 1mm thick DIN rail for assembly.
The following two heights are commonly used.

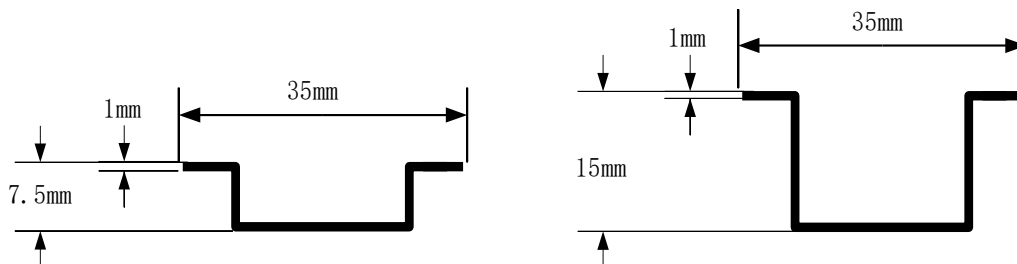

Fig.9.2-1 Standard DIN Rail



Notes: When the rail thickness <math>< 1\text{mm}</math>, the latch may not lock securely, causing looseness. When >math>1\text{mm}</math>, the latch may not close properly, and forcing it to lock could damage the module.

9.2.2 Module Assembly

Modules are effectively connected through the positional relationship between the top rail and the bottom rail.

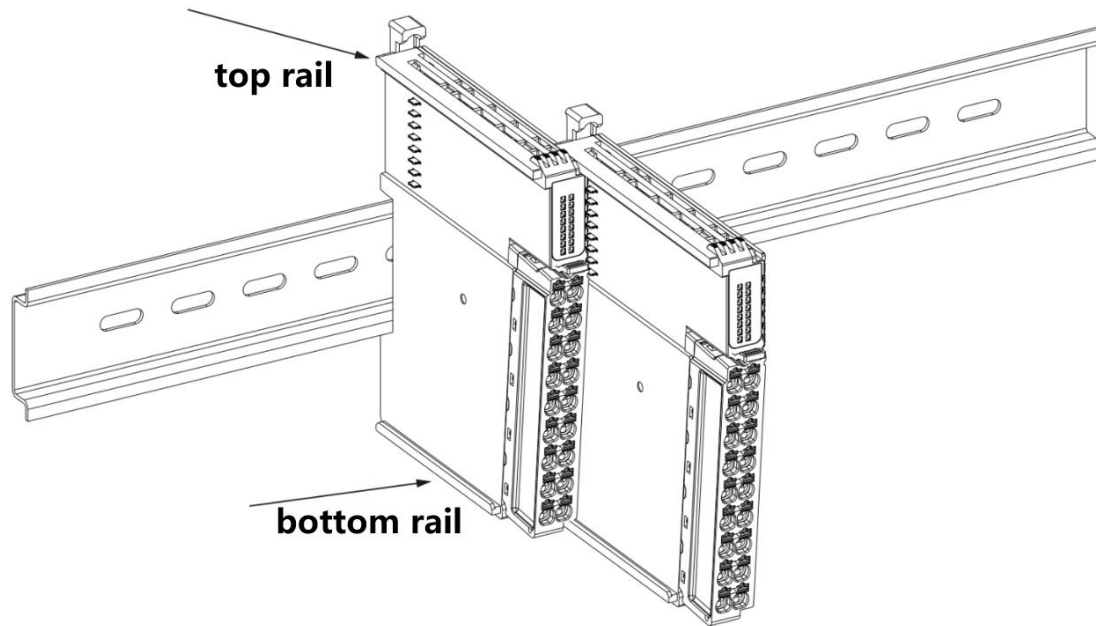

Fig.9.2-2 Module assembly

When assembling modules, align the top and bottom rails of the module to be connected with the rails of the target module. Simultaneously clip them onto the rails, then push the module vertically until it is fully inserted and aligned.

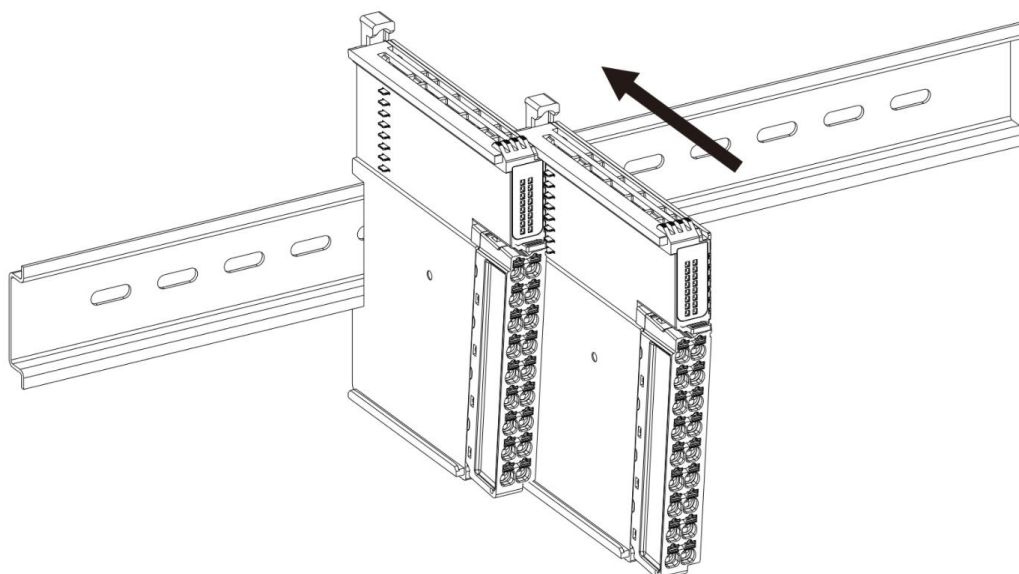

Fig.9.2-3 Module assembly

To secure the module onto the DIN35 rail, first pull the spring lever at the top of the module upward. Then, clip the module vertically onto the rail. Release the lever, and the locking mechanism will automatically snap back to secure the module in place.

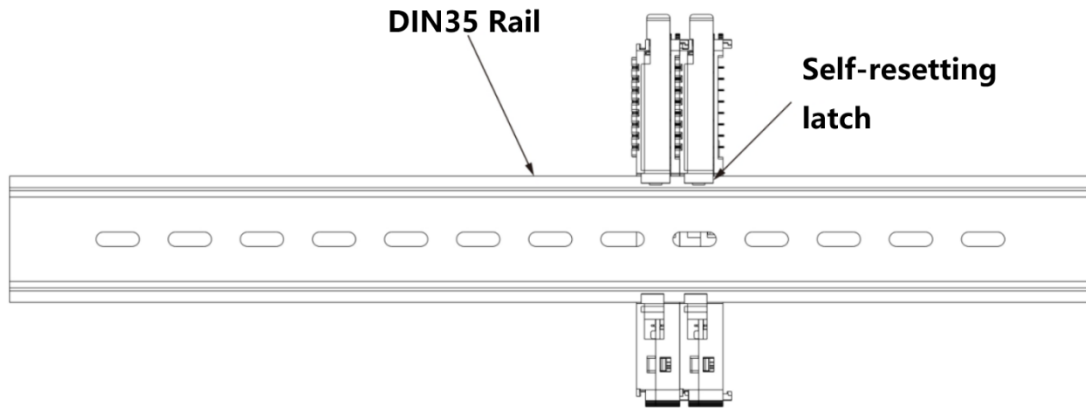

Fig.9.2-4 Secure the module onto the DIN35 rail

After all modules are assembled, use rail fixing blocks that are compatible with the rail size to secure the modules in their intended positions on the rail. This prevents improper displacement during mechanical vibrations or transportation, ensuring system safety.

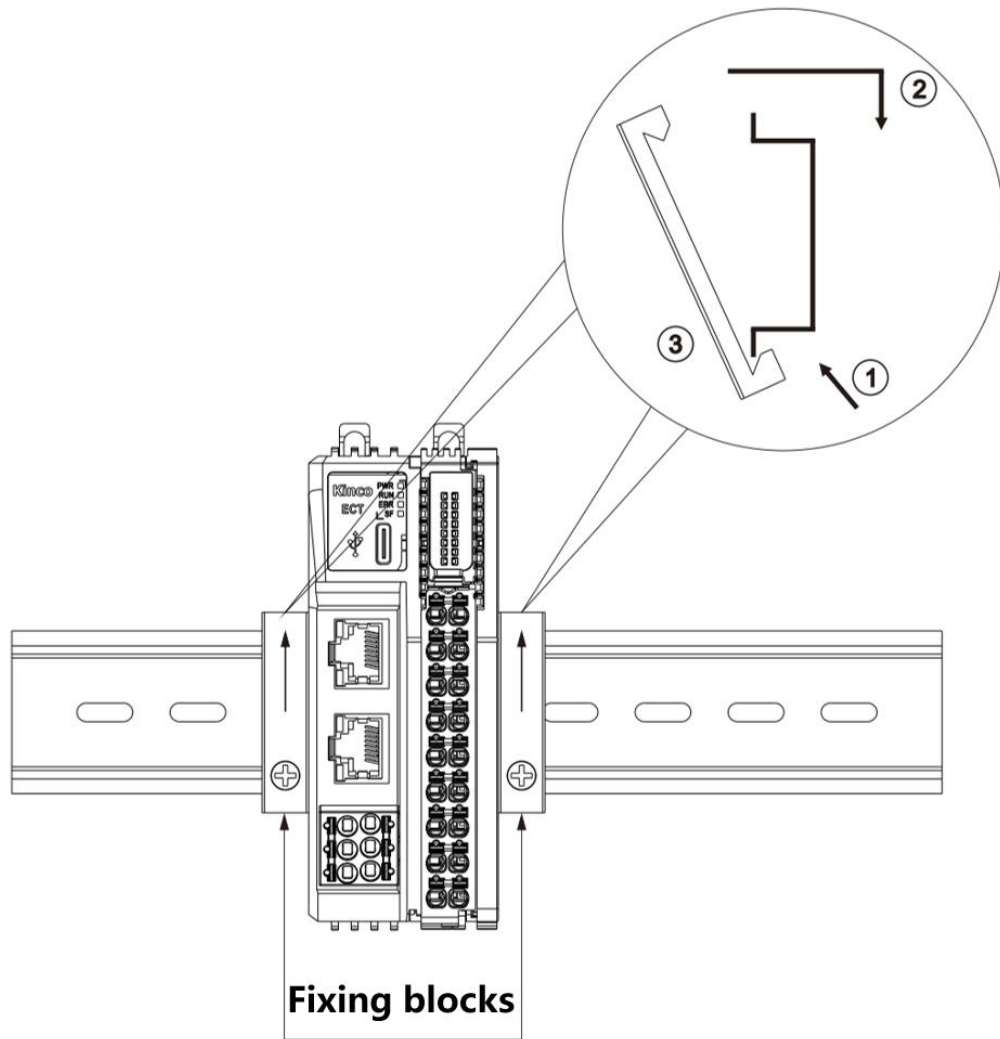

Fig.9.2-5 Fixing blocks assembly

During disassembly, first loosen the rail fixing block, then use a flathead screwdriver or other tools to lift the spring-loaded self-locking latch on top of the module. Afterward, remove the module from the rail.

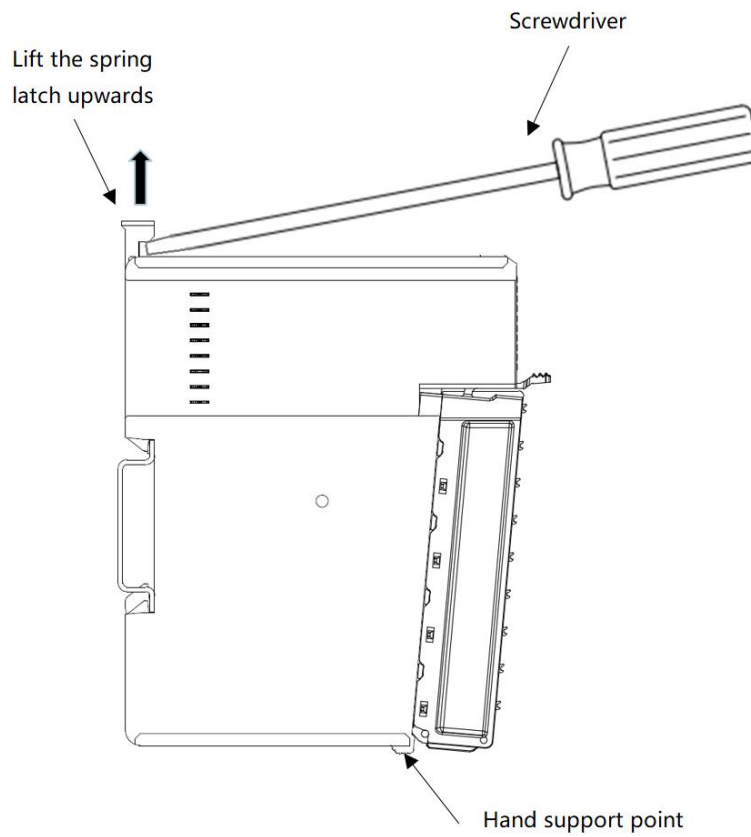

Fig.9.2-7 Module disassembly



Notes: Rail fixing blocks must match the size of the DIN rail. Customers should purchase the blocks separately based on their specific requirements.

9.2.2 Connector Assembly

When connector disassembly:

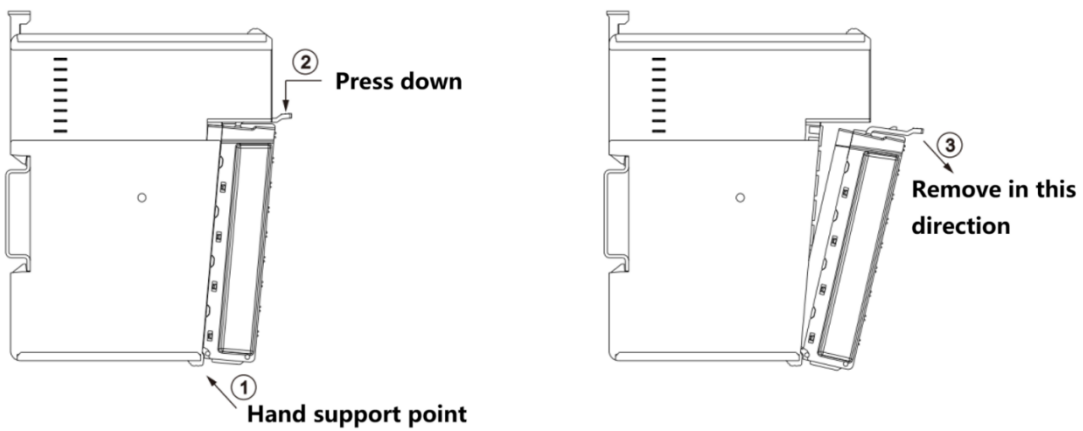

Fig.9.2-8 connector disassembly

When connector assembly:

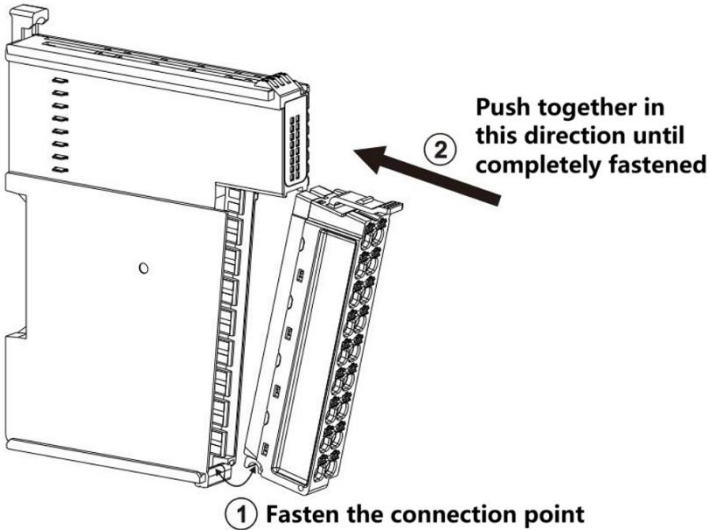

Fig.9.2-9 connector assembly

The module terminals (front connection area) are equipped with cable fixing points. Using accessories such as cable clamps or straps, I/O cables can be secured, making cable management easier and more organized.



Fig.9.2-10 Cable management

10 Getting Start

10.1 Device Description File Acquisition

The I/O modules do not have separate device description files. Instead, they are integrated into the device description file of the RP20 series coupler or the device installation package of the AK8X0 series PLC. Please visit the Kinco official website <https://www.kinco.cn/>(CN), <https://en.kinco.cn/> (EN) or contact Kinco's official customer service department to obtain the latest device description files.

10.2 Install Device Description File

10.2.1 When Used with RP20 Coupler

10.2.1.1 Installation

This chapter demonstrates the device installation process using the standard CoDeSys-style interface (CoDeSys V3.5.19) and RP20 EtherCAT coupler.

Step 1: Open CoDeSys V3.5.19, locate and open the "Device Repository" under the "Tools" menu.

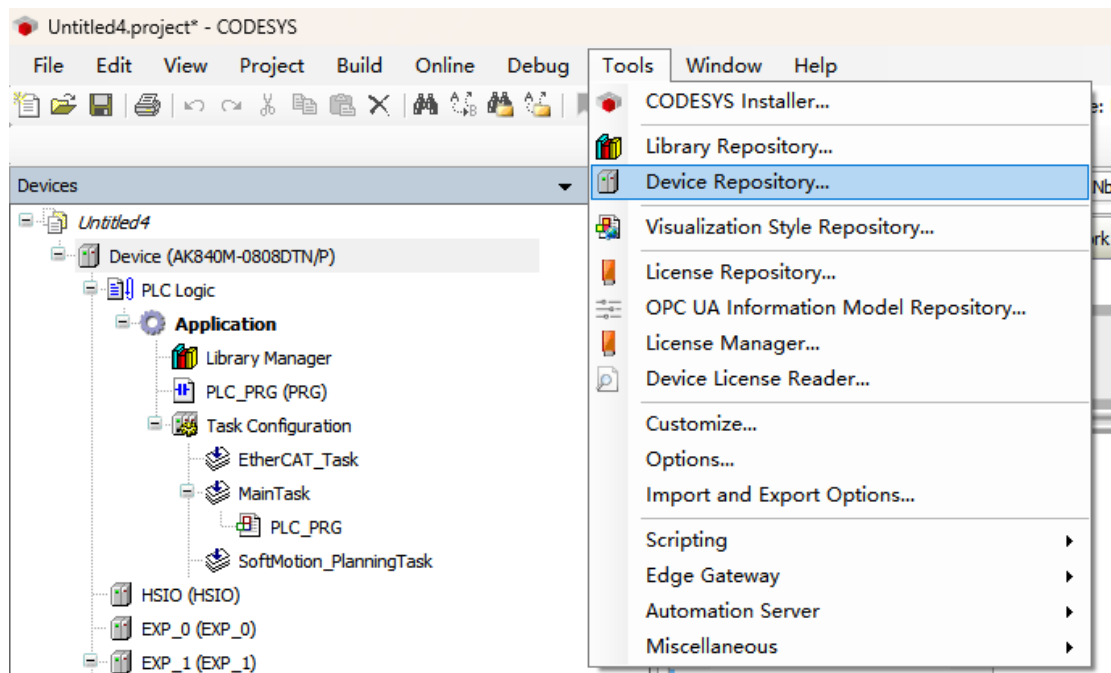

Fig. 10.2.1-1 Open "Device Repository"

Step2: Select the "Install.." option, locate the target file in the opened directory, and open it.

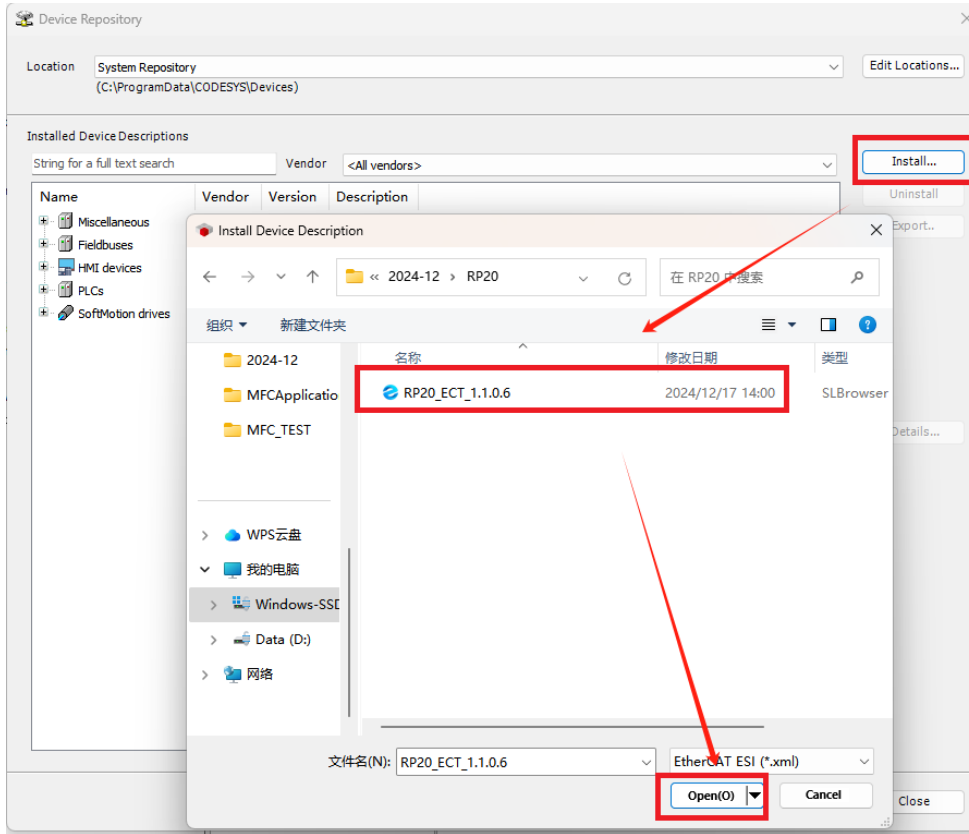

Fig. 10.2.1-2 Select file and install

Step3: Wait for the installation to finish.

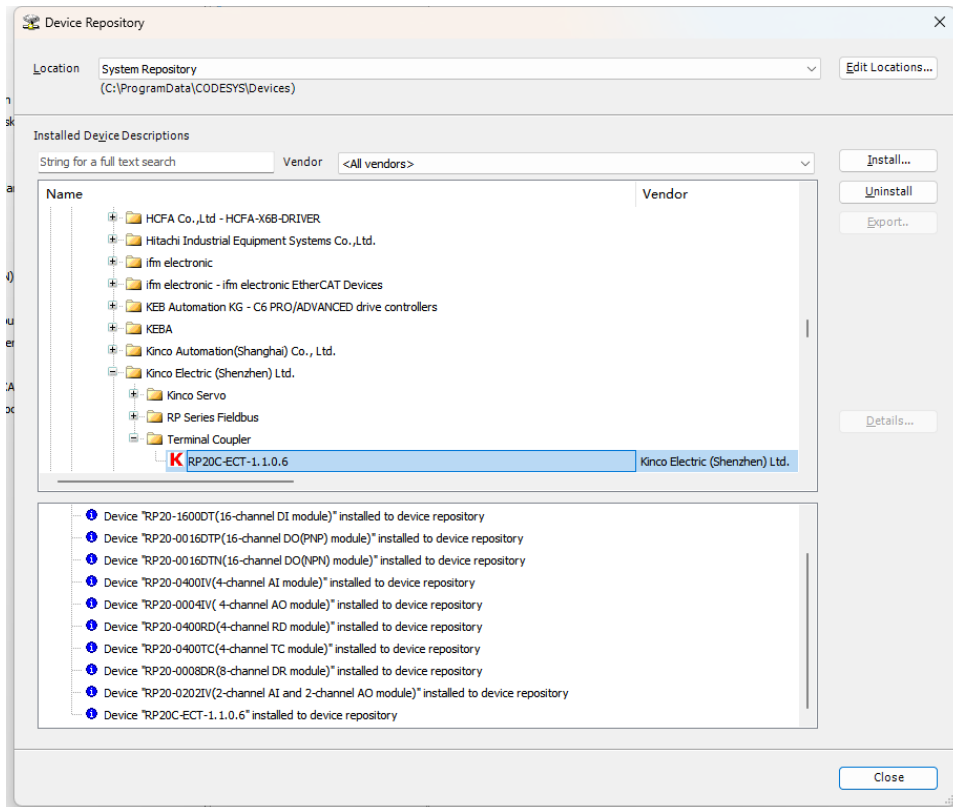

Fig. 10.2.1-3 Wait for the installation to complete

10.2.1.2 Configuration

This section demonstrates the configuration process for RP20 series I/O modules using the RP20 series EtherCAT coupler as an example. The RP20 series offers 2 configuration methods:

Method 1: Configuration via scanning. This method requires an actual slave device to be connected.

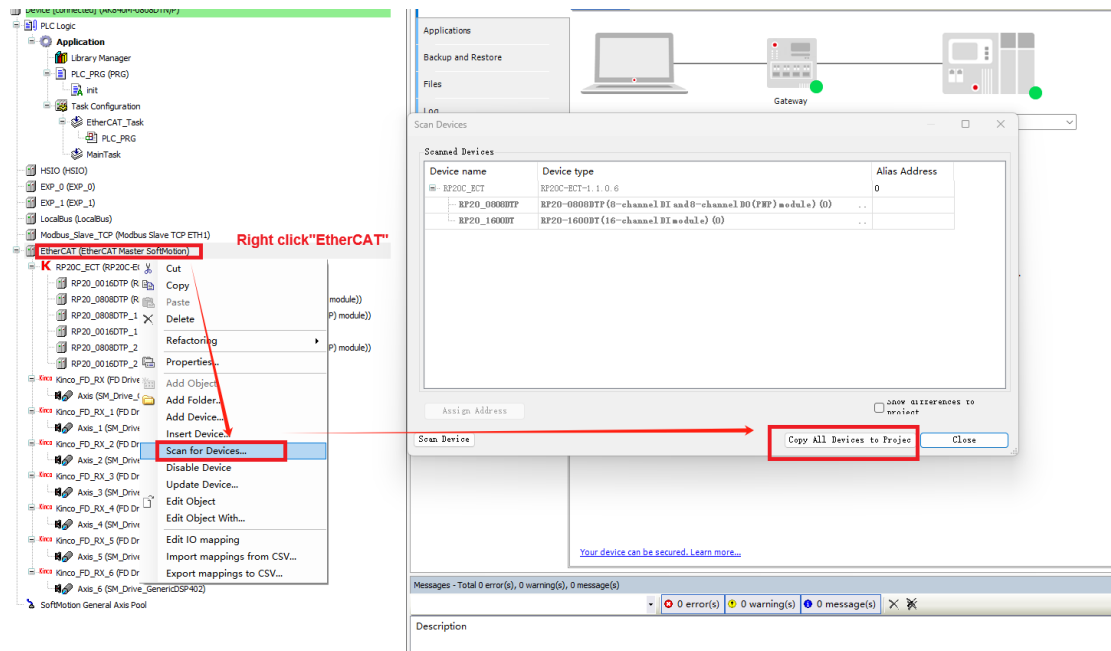

Fig. 10.2.1-4 Scan for devices

Method 2: Configuration by manually adding modules. For this method, the order of module addition must match the actual connection sequence of the modules; otherwise, communication errors will occur.

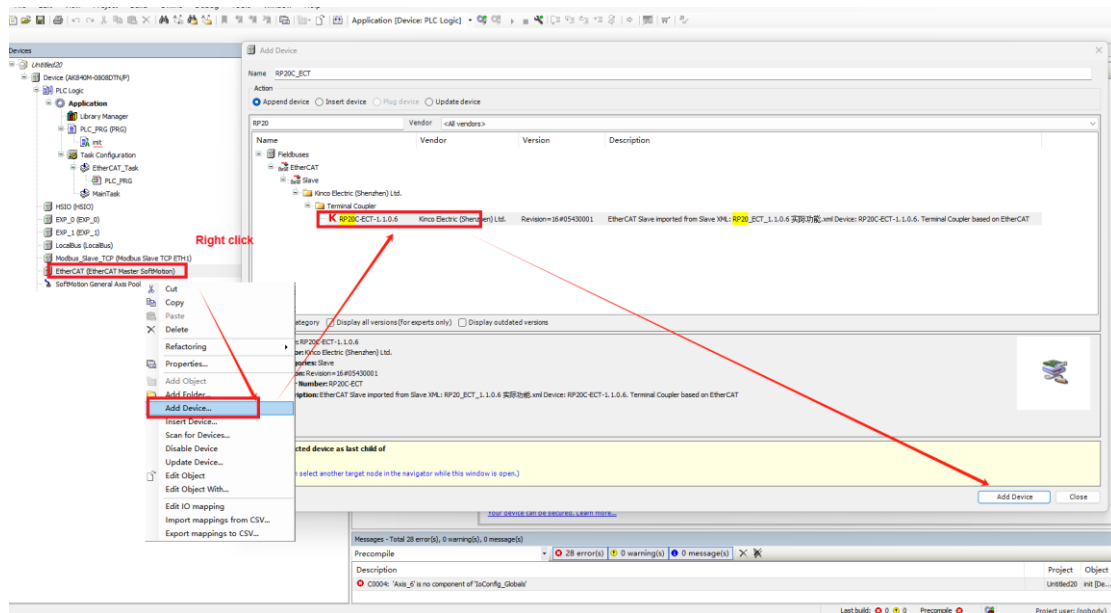

Fig. 10.2.1-5 Add the coupler

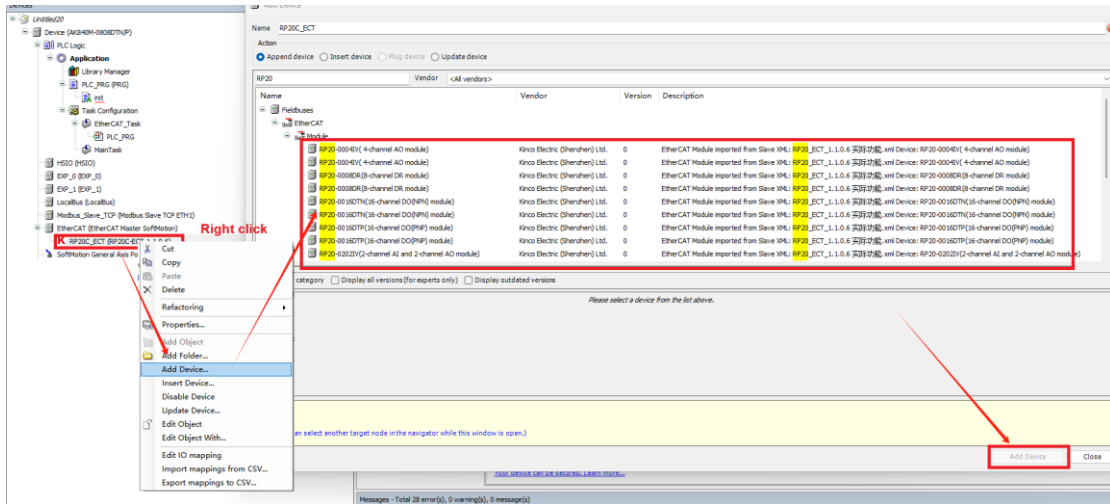

Fig. 10.2.1-6 Add modules

10.2.1.3 Usage Demonstration

The digital modules of the RP20 series are defined as byte transfer in the device description. After configuration, each module is automatically assigned a unique address, which can be viewed and utilized in the "Module I/O Mapping" interface in the configuration panel.

Below is a demonstration of the configuration process using a coupler in CoDeSys V3.5.19.

Method 1: Direct addresses usage (Byte /Bit)

During variable definition, map the corresponding I/O channel address to a specific variable or directly use the channel address.

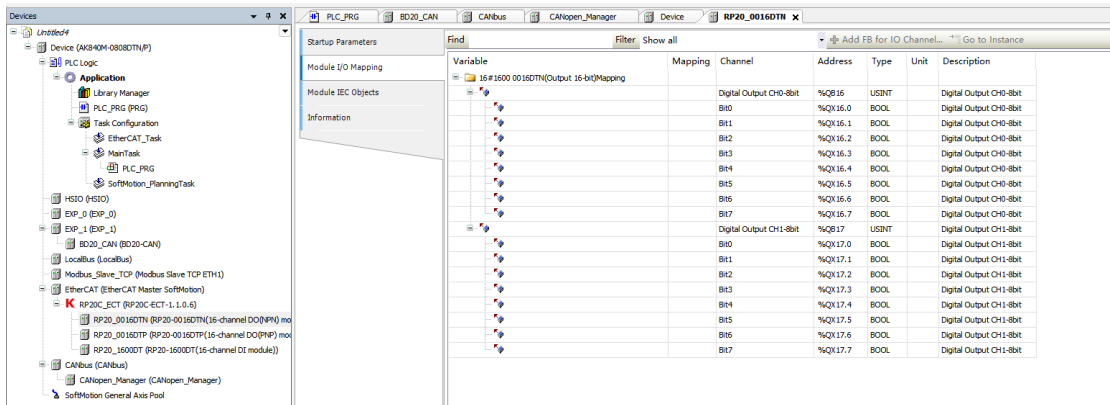

Fig. 10.2.1-7 "Module I/O Mapping"

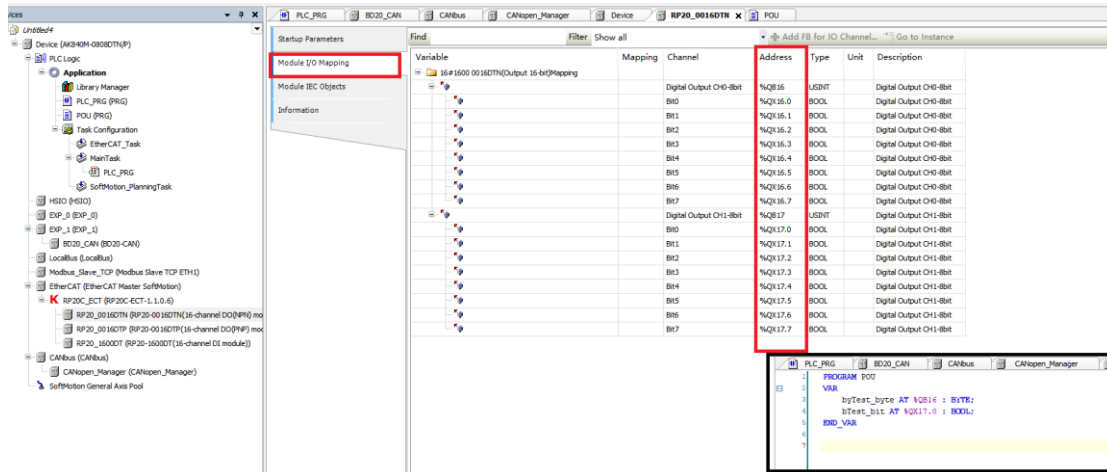

Fig. 10.2.1-8 Use the address directly

Method 2: Address Mapping (Byte /Bit)

In this method, the I/O channel addresses are directly mapped to specific variables through the "Module I/O Mapping" interface. This allows the variables to be directly associated with the corresponding I/O channels for use in the program.

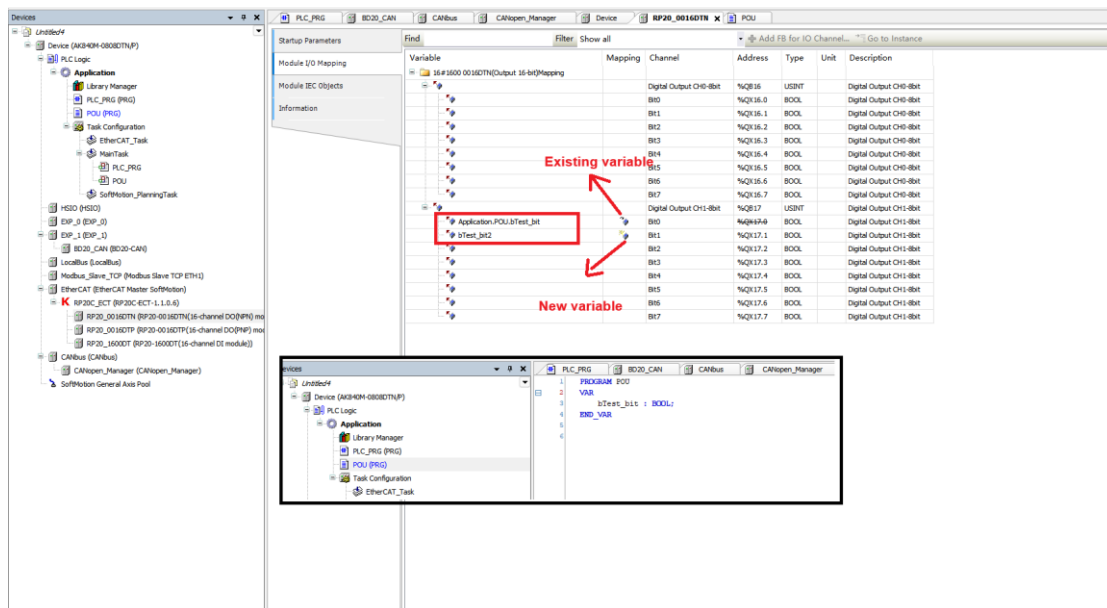

Fig. 10.2.1-9 Address mapping

10.2.2 When used with AK840M Controller

This chapter demonstrates the device installation process using the standard CoDeSys-style interface (CoDeSys V3.5.19).

10.2.2.1 Installation

Step 1: Open CoDeSys V3.5.19, locate and open the "CODESYS Installer" under the "Tools" menu.

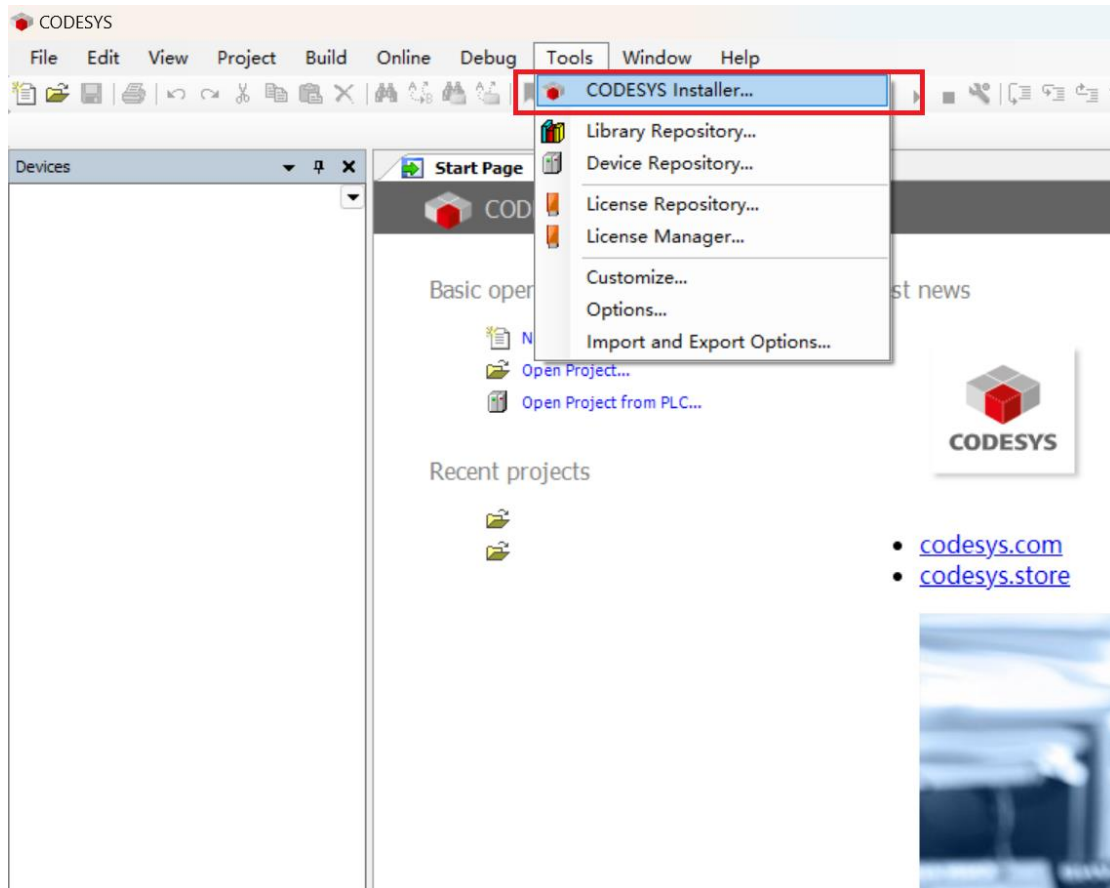

Fig. 10.2.2-1 Open 'CODESYS installer'

Step 2: In the CODESYS Installer, click **Install File** to select the device you want to install. Before installation, please close the CODESYS software as instructed, otherwise the installation cannot proceed.

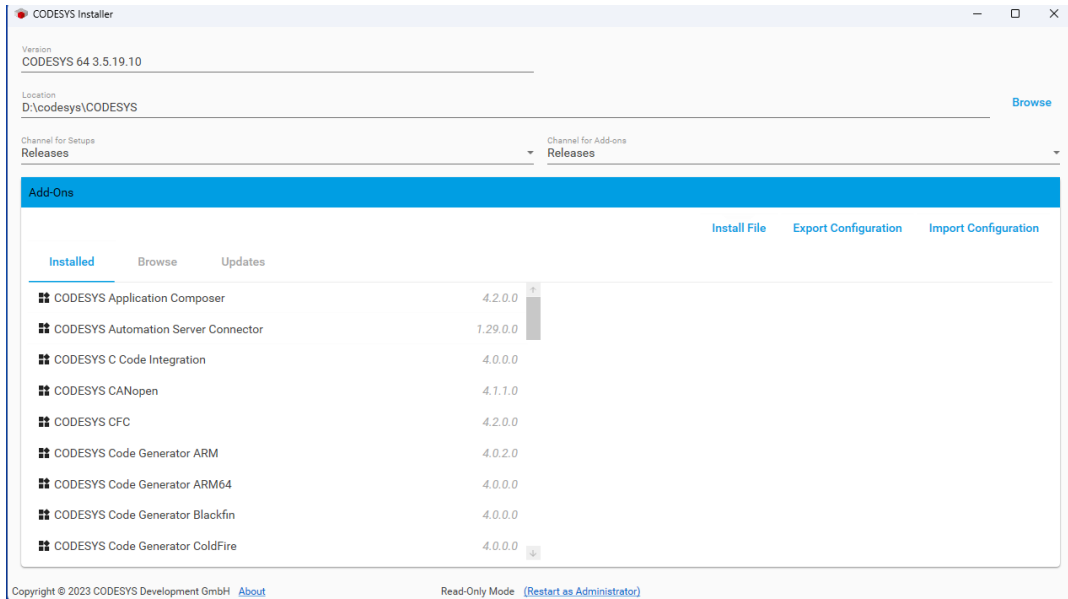

Fig. 10.2.2-2 Select file and install

Step 3: After the prompt box appears, check the box 'I want to continue despite the missing signature', and click 'Continue' to proceed with the next step of the installation.

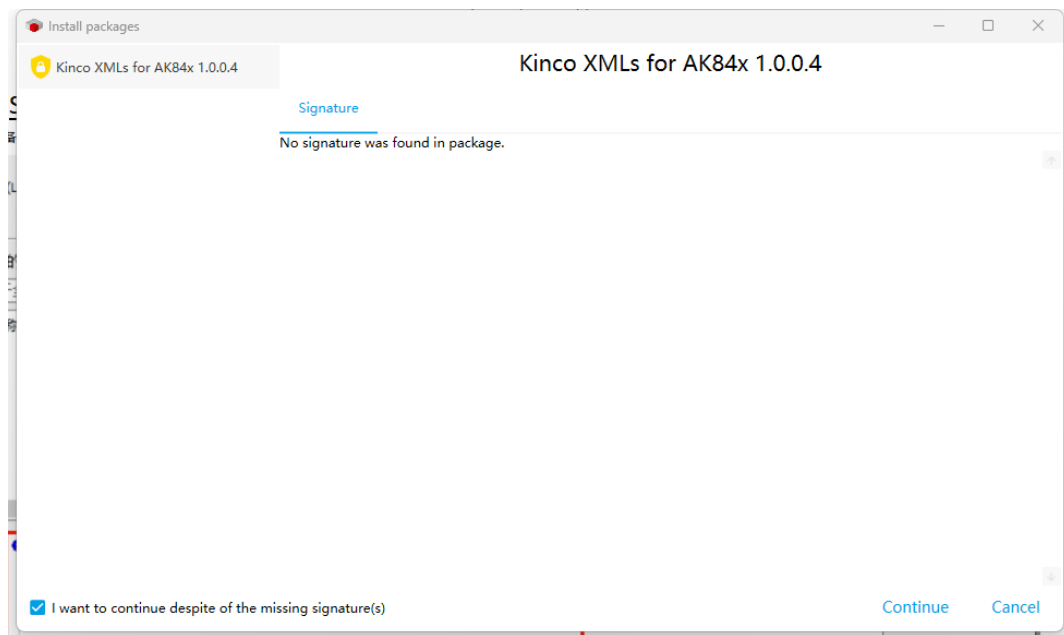

Fig. 10.2.2-3 Click 'Continue' to proceed

Step 4: Please wait patiently for the installation to complete.

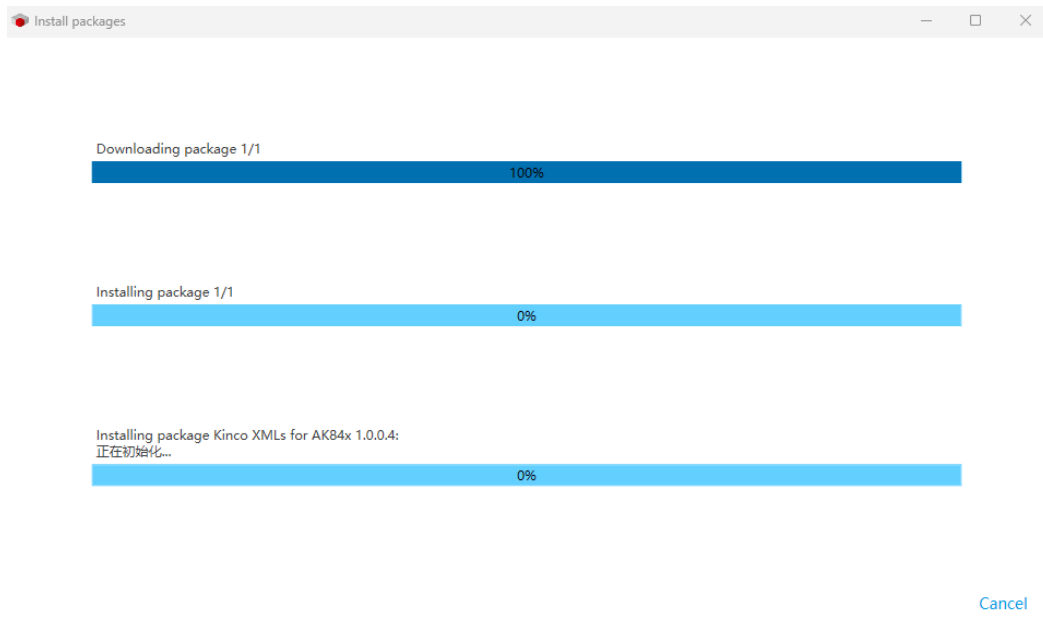

Fig. 10.2.2-4 Wait for the installation to complete

Step 5: Wait for the installation to finish. After that, you can close the installer and restart CODESYS software.

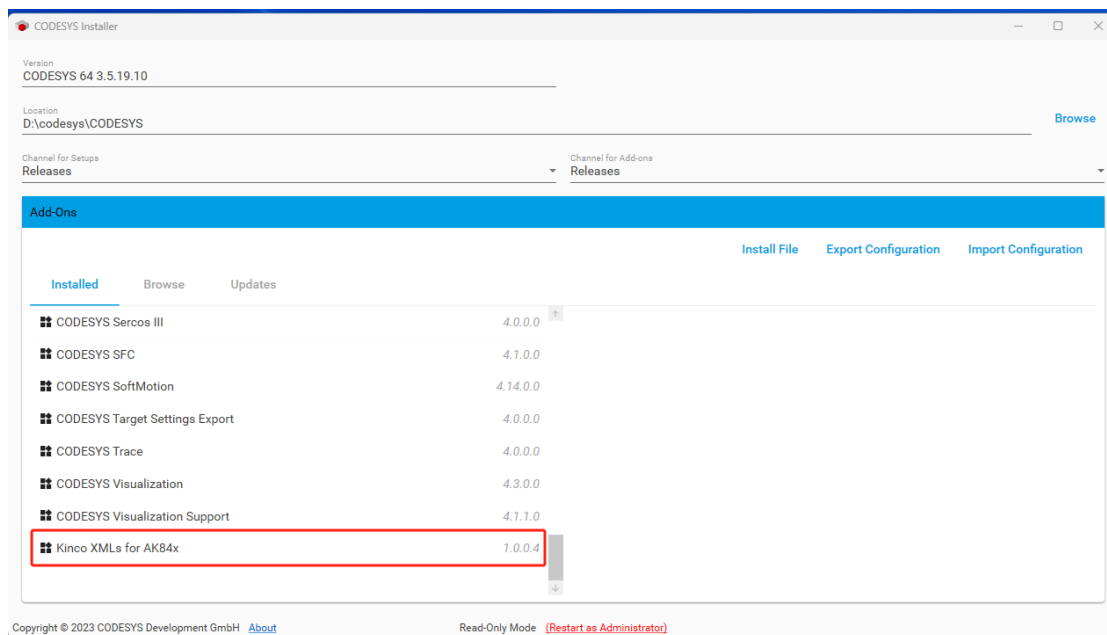

Fig. 10.2.2-5 Installation complete

10.2.2.2 Configuration

Configure under "localbus" by manually adding modules. This method requires manually adding I/O modules, ensuring the addition sequence matches the actual module connection sequence. Otherwise, communication errors may occur.

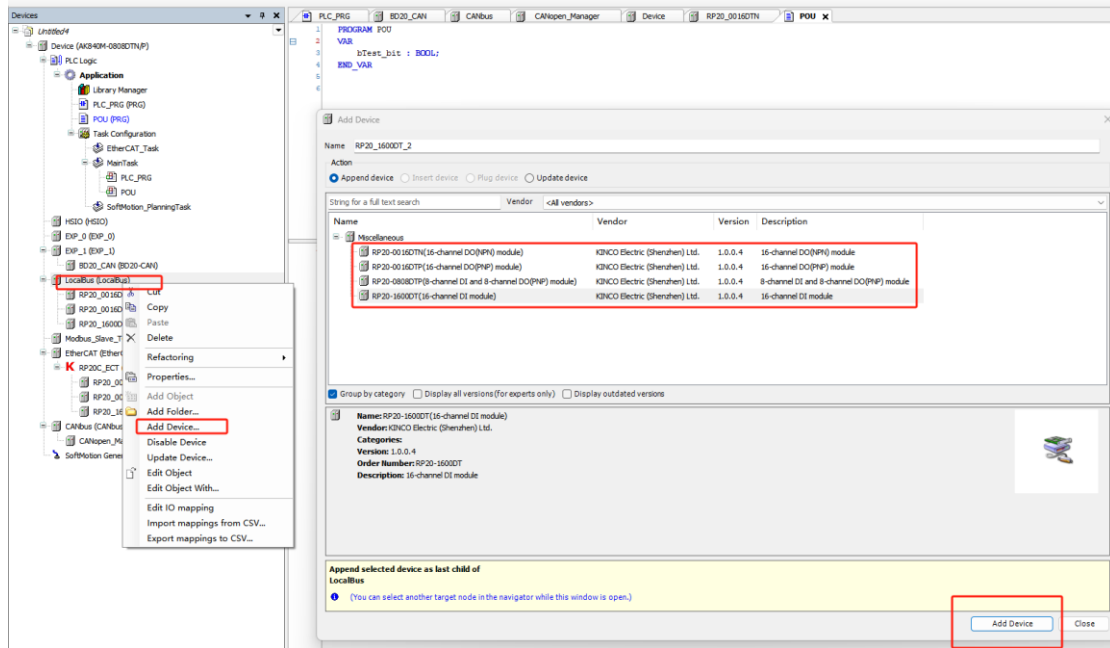

Fig. 10.2.2-6 Configure under "localbus"

10.2.2.3 Usage Demonstration

The digital modules of the RP20 series are defined as byte transfer in the device description. After configuration, each module is automatically assigned a unique address, which can be viewed and utilized in the "Module I/O Mapping" interface in the configuration panel.

The usage method is identical to that described in [Section 10.2.1.3](#). Please refer to that section for details.

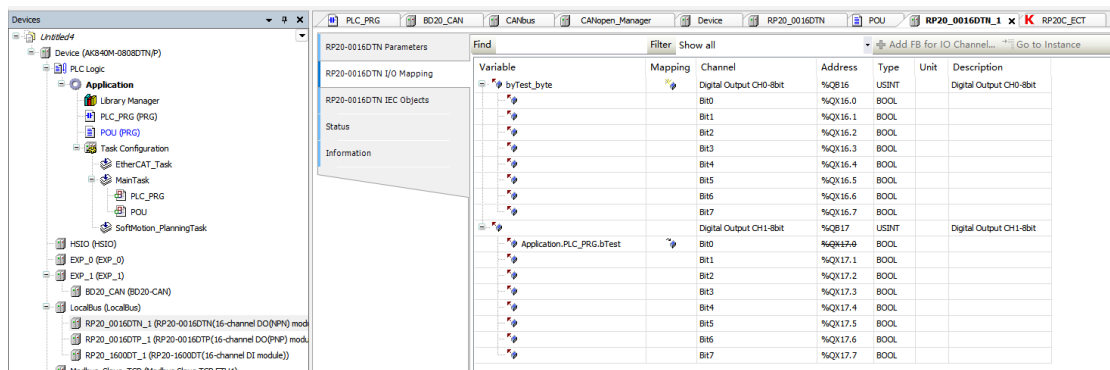

Fig. 10.2.2-7 "Module I/O Mapping"

11 Error Diagnostics

When the module's Err indicator (red) lights up, it indicates a fault in the module. The fault code can be obtained through the online monitoring interface of the master station software. The object dictionary for the fault code is 0xA000.

The corresponding module object dictionary index is related to the module's position under the coupler (n=1~16). The relationship between the index and the position is as follows:

$$\text{Index} = 0xA000 + 0x10 \times (n-1)$$

For example, if three modules are connected in the "Online CoE" interface in CoDeSys (Fig. 11.1-1), the corresponding fault indices would be: 0xA010, 0xA020, 0xA030.

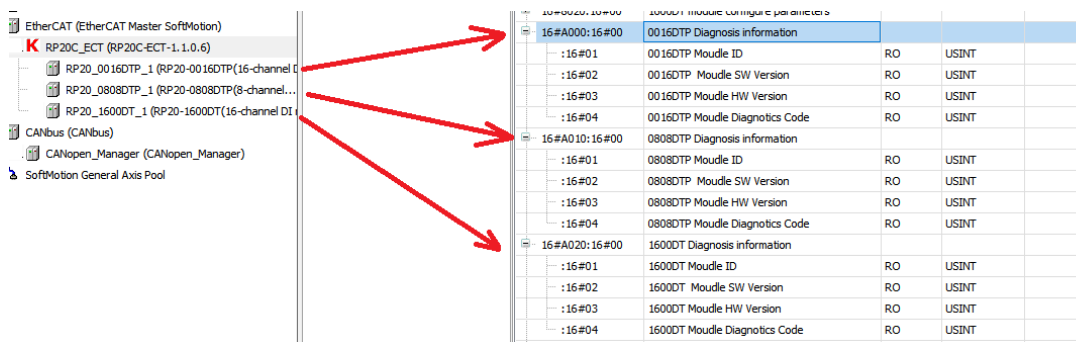

Fig. 11.1-1 "CoE Online" Tag

Object Dictionary Index Definition		
0xA000+0x10*(n-1)		
Sub-index	Type	Definition
01	UINT8	Module ID
02	UINT8	Module SW Version / Software version
03	UINT8	Module HW Version / Hardware version
04	UINT8	Module Diagnosis information / Error code

The object dictionary index $0xA000 + 0x10 \times (n-1)$ has a specific entry for the module error code at 0x04. Below are some common error codes and their meanings:

Code	Definition
0x01	Error caused by the master device. Please check the master device's status and perform fault diagnosis (refer to the corresponding user manual of the master device).
0x02	Error caused by the module itself.
0x03	The module ID returned by the module is invalid. Please check the module configuration and module position.