

ESM-104-H-200+ESG-104-H-R200-P

NO.	COUNT	REVISIONS	DATE (YY/MM/DD)	APPROVED
△	x		' / /	
△	x		' / /	

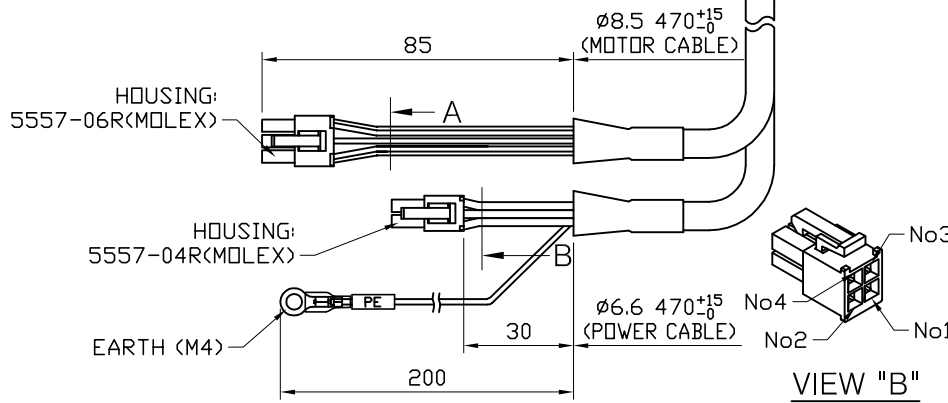

NOTE
1. 400W와 외형도 같음.

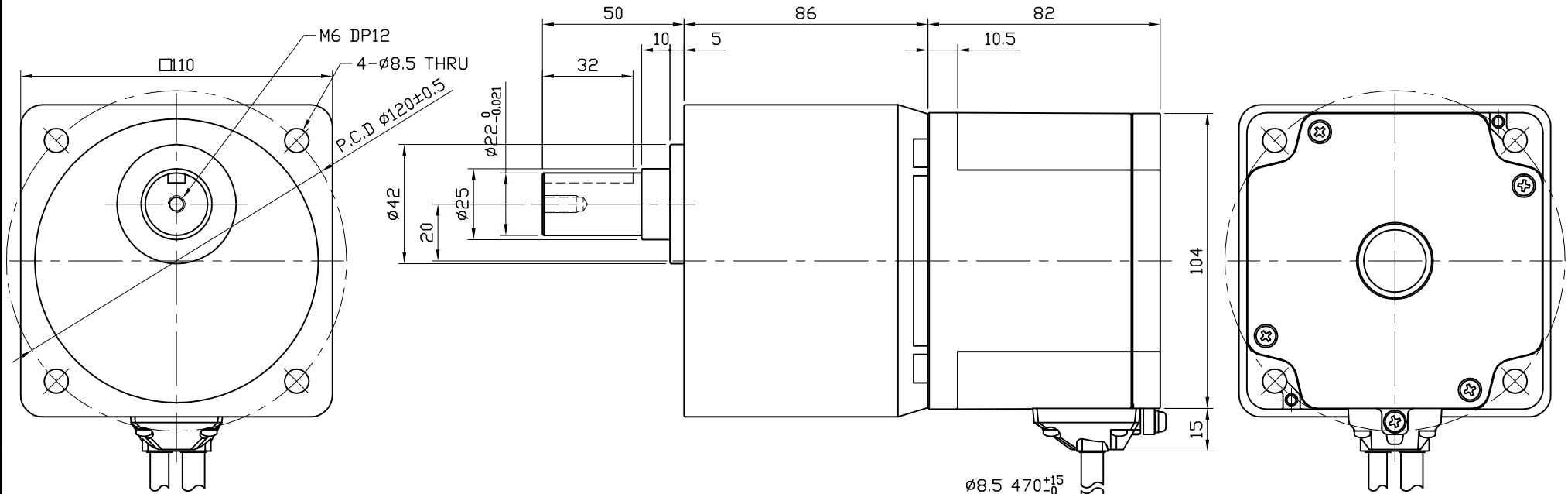
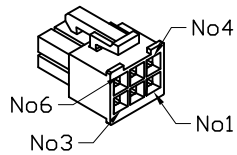

VIEW "A"

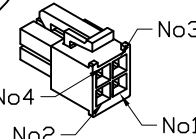

VIEW "B"

- PIN MAP (MOLEX 5557-04R)

PIN NO.	COLOR	WIRE SPEC	SIGNAL
1	-	-	-
2	BLUE	UL3266 AWG22	U
3	GRAY	UL3266 AWG22	W
4	PURPLE	UL3266 AWG22	V

- PIN MAP (MOLEX 5557-06R)

PIN NO.	COLOR	WIRE SPEC	SIGNAL
1	YELLOW	UL3266 AWG24	Vcc
2	BLACK	(DRAIN)	-
3	GREEN	UL3266 AWG24	Ground
4	BROWN	UL3266 AWG24	Hu
5	WHITE	UL3266 AWG24	Hv
6	ORANGE	UL3266 AWG24	Hw

● KEY

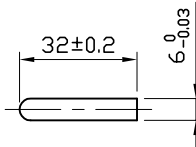

● KEY GROOVE

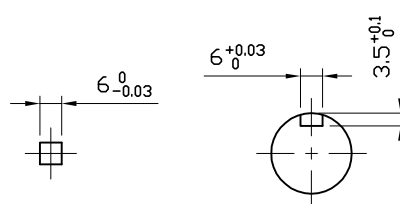

UNLESS OTHERWISE SPECIFIED, DIMENSIONS ARE IN MILLIMETERS AND TOLERANCES ARE AS FOLLOWS:

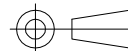

Mechatronics Division



SIZE	SCALE	QUANTITY	MATERIAL	REMARK
A4	1/2	1		
DRAW Kim. Y. C.		DATE (YY/MM/DD) '17/06/09	TITLE Ezi-SPEED	SHEET 1 OF 1
CHECK Kim. Y. C.		DATE (YY/MM/DD) '17/06/09	MODEL ESM-104-H-200+ESG-104-H-R200-P	
APPROVED		DATE (YY/MM/DD) / /	DRAWING NO. P91-MO-104-04	