

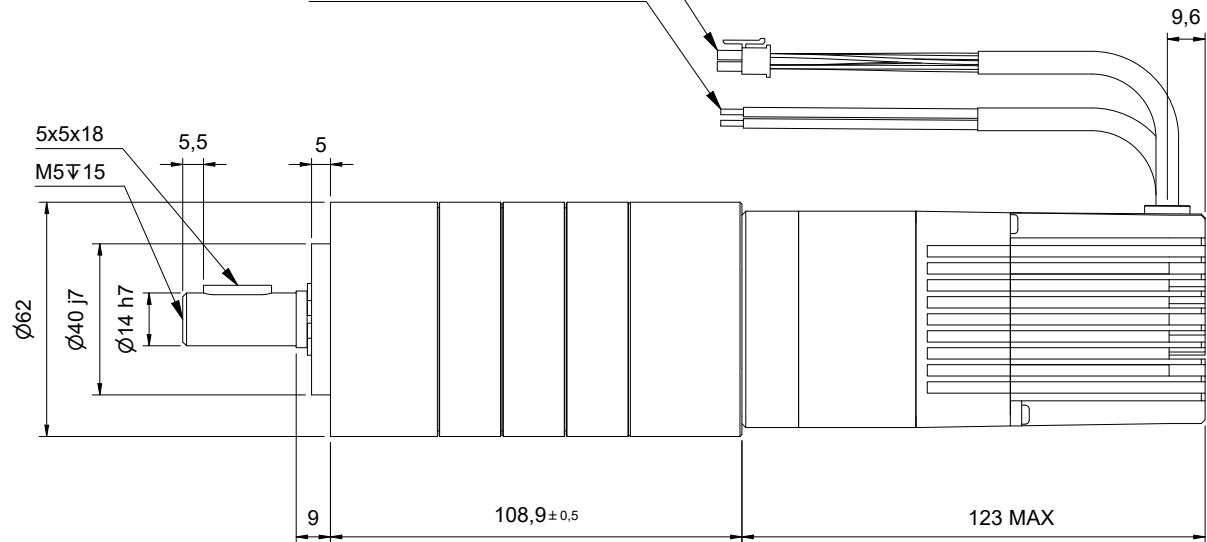

Command cable 12 x AWG26 / 500mm

Power cable 2 x AWG16 / 500mm

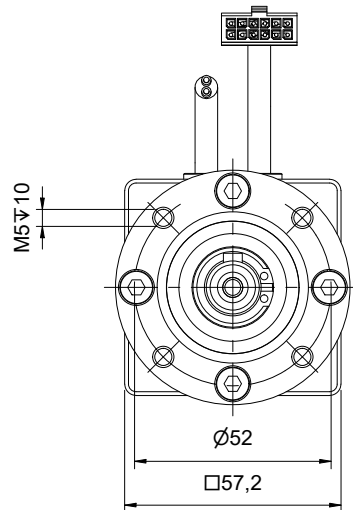

Article nr. : -		Checked by : RN	
Description : 80140-SMi21 + PM62LN-3-LF		Approved :	
 Zilvertron mechanics & electronics	Zilvertron B.V. De Smaragd 15 2872 ZT Schoonhoven The Netherlands T: +31(0)182-305045 E: info@zilvertron.com W: www.zilvertron.com		Date. : 22-2-2021 Rev. : 0
	Drawn : MDV A4 Scale : 1 : 2	Unless otherwise specified: Dimensions in millimeters Tolerances: ISO 2769-m Debur and break edges	

Rev Nr.	Revision Note	By	Date	Checked by
00				

All rights reserved to Zilvertron B.V.