

DCmind: BRUSHLESS MOTORS

Motors 38 to 145 W nominal output power range TNi21



- › For control, speed and torque applications
- › Very high power density
- › 4 inputs (where 2 of them analog) / 3 outputs integrated electronic controls
- › Holding torque function
- › Battery supply compatible 12 V and 24 V

Part numbers

Type	38 to 75 W	45 to 102 W	72 to 145 W
Part numbers	80140 TNi21	80180 TNi21	80280 TNi21
PWM speed mode, cable output	80140059	80180056	80280013
0-10 V speed mode, cable output	80140051	80180050	80280007
PWM speed mode, connector M16 - 12 pins	80140079	80180072	
0-10 V speed mode, connector M16 - 12 pins	80140071	80180066	
Nominal power supply range (V ₋₋₋)	12 - 32	12 - 32	12 - 32
Min. max. power supply (V ₋₋₋)	10 - 36	10 - 36	10 - 36
No-load characteristics	12 V ₋₋₋ 24 V ₋₋₋ 32 V ₋₋₋	12 V ₋₋₋ 24 V ₋₋₋ 32 V ₋₋₋	12 V ₋₋₋ 24 V ₋₋₋ 32 V ₋₋₋
Speed of rotation (rpm)	2900 4000 4000	2100 4000 3950	2000 3950 3950
Absorbed current (A)	0.34 0.29 0.27	0.35 0.39 0.34	0.5 0.7 0.6
Nominal characteristics	12 V ₋₋₋ 24 V ₋₋₋ 32 V ₋₋₋	12 V ₋₋₋ 24 V ₋₋₋ 32 V ₋₋₋	12 V ₋₋₋ 24 V ₋₋₋ 32 V ₋₋₋
Speed (rpm)	1900 4000 4000	1250 3350 3900	1400 3250 3900
Absorbed current (A)	5.2 4.4 3.2	6.7 5.4 4	8.5 6.9 6
Torque (mNm)	193 184 178	340 285 250	490 390 355
Output power (W)	38 77 75	45 100 102	72 133 145
Maximal characteristics	12 V ₋₋₋ 24 V ₋₋₋ 32 V ₋₋₋	12 V ₋₋₋ 24 V ₋₋₋ 32 V ₋₋₋	12 V ₋₋₋ 24 V ₋₋₋ 32 V ₋₋₋
Speed (rpm)	1600 3050 4000	1040 2160 3100	800 1900 2400
Absorbed current (A)	6.5 10 10	7.2 11 12	15 15 12.5
Torque (mNm)	250 358 358	400 600 650	1000 1000 1000
Output power (W)	42 114 150	44 136 211	84 199 251
General characteristics			
Regulation (quadrants)	4	4	4
Conformity to EMC Directive in accordance with (EN 55022)	Class B	Class B	Class B
Insulation conforming to IEC60085	Class E	Class E	Class B
Thermal time constant (mn)	20	30	30
Noise level (dBA)	40	40	50
Inertia (g.cm ²)	75	115	120
Number of rotor poles	4	4	8
Ambient operating temperature (°C)	-30 → +70	-30 → +70	-30 → +70
Service life (h)	20000	20000	20000
Ball bearing	✓	✓	✓
Weight (kg)	0.95	1.34	1.44
0-10 V or PWM Speed input characteristics			
Input impedance (kΩ)	69	69	69
Speed control (rpm)	120 → 4000	120 → 4000	120 → 4000
Level 0 input voltage (V)	0 → 2	0 → 2	0 → 2
Level 1 input voltage (V)	7.5 → 39	7.5 → 39	7.5 → 39
Frequency range (Hz)	100 → 2000	100 → 2000	100 → 2000
0-10 V or PWM Torque input characteristics			
Input impedance (kΩ)	69	69	69
Torque limit (mNm)	360 → 35	700 → 30	1000 → 40
Holding limit (mNm)	150 → 35	230 → 30	310 → 40
Level 0 input voltage (V)	0 → 2	0 → 2	0 → 2
Level 1 input voltage (V)	7.5 → 39	7.5 → 39	7.5 → 39
Frequency range (Hz)	100 → 2000	100 → 2000	100 → 2000
On/Off and Direction digital input characteristics			
Input impedance (kΩ)	57	57	57
Level 0 input voltage (V ₋₋₋)	0 → 2	0 → 2	0 → 2
Level 1 input voltage (V ₋₋₋)	4 → 39	4 → 39	4 → 39
Torque alarm, Encoder and Direction output characteristics			
Type of output-Maximum admissible current (mA)	PNP	PNP	PNP
Maximum admissible current (mA)	50	50	50
IP54 over the whole motor apart from the shaft output. Versions with brake are IP20			
Accessory			
2 metre shielded cable with 12-pin female M16 connector			15275008

Curves

Speed / Torque 80140 TNi21 - Current / Torque 80140 TNi21

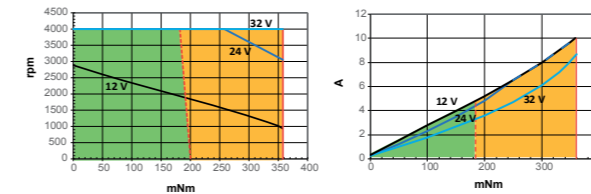

Speed / Torque 80180 TNi21 - Current / Torque 80180 TNi21

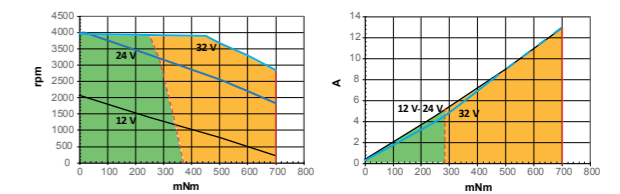

Speed / Torque 80280 TNi21 - Current / Torque 80280 TNi21

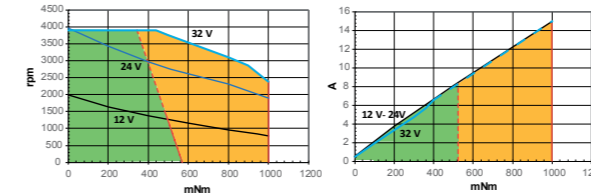

- Continuous running area
- Cycling running area
- Maximum continuous torque
- Maximum peak torque

Dimensions (mm)

Cable output versions

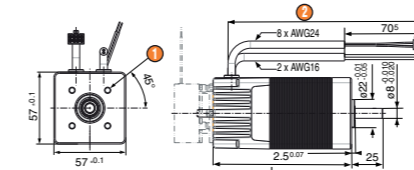

M16 connector version - 12 pins

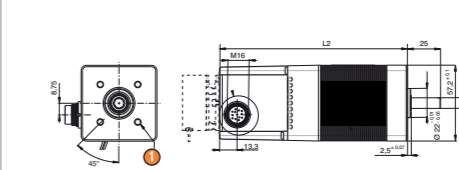

- L: 80140: 92 max
 - L: 80180 / 80280: 112 max
 - L2: 80140: 123 max
 - L2: 80180 / 80280: 143 max
- More information: see page 16

Connections

	Connector M16	Cable color
Power ground	G+M	AWG16 Blue
Power supply 24 V	E+F	AWG16 Brown
Logic ground	H	AWG24 Black (5)
Input 1: On/Off	C	AWG24 Green (1)
Input 2: Direction	B	AWG24 Yellow (2)
Input 3: Speed	J	AWG24 Orange (4)
Output 1: Tachometer	A	AWG24 Brown (6)
Output 2: Real direction	L	AWG24 Red (8)
Input 4: Torque	D	AWG24 Blue (3)
Output 3: Torque at max.	K	AWG24 Purple (7)

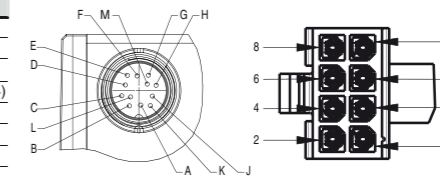

Options

Holding brake 0.5 Nm - 24 V₋₋₋

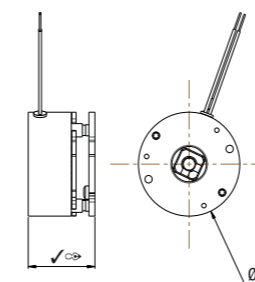

- › Shaft, pinion, pulley dimensions
- › Cable wire length
- › Powerful controlled brake (directed)
- › Programs evolution

User information

Notice available on website, please read it before use.

DC DIRECT DCmind BRUSHLESS TNi21 & SMi21

Dimensions (mm)

80140 - 80180 - 80280 - TNi21 version output cable with or without brake

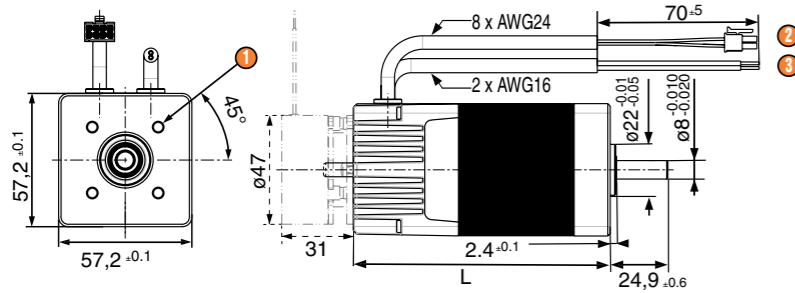

L 80140: 92 max.
L 80180: 112 max.
L 80280: 112 max.

- 1 4 x M5 at 90°, depth 6 over Ø 40
- 2 Command cable 8 x AWG24 / 500 mm
- 3 Power cable 2 x AWG16 / 500 mm

80140 - 80180 - TNi21 version connector M16 - 12 pins with or without brake

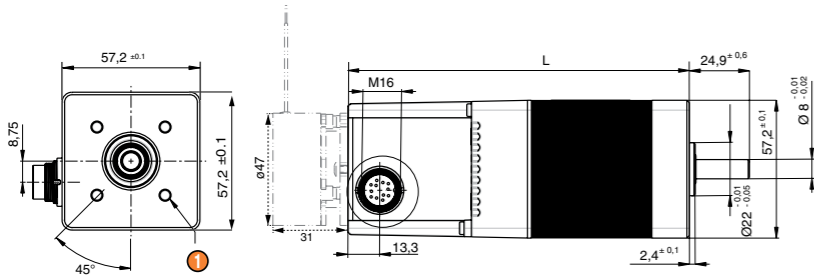

L 80140: 123 max.
L 80180: 143 max.

- 1 4 x M5 at 90°, depth 6 over Ø 40

80140 - 80180 - 80280 - SMi21 with or without brake

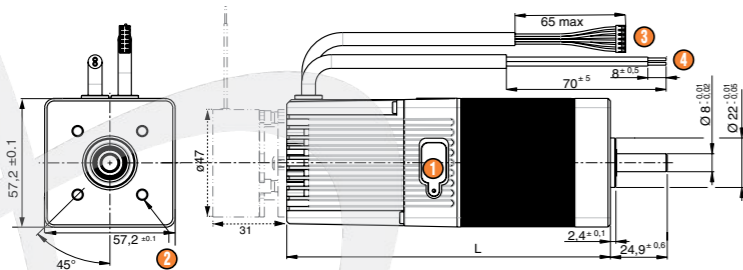

L 80140: 123 max.
L 80180: 143 max.
L 80280: 143 max.

- 1 USB connection type A or B
- 2 4 x M5 at 90°, depth 6 over Ø 40
- 3 Command cable 10 x AWG24 / 500 mm
- 4 Power cable 2 x AWG16 / 500 mm

DC GEARED DCmind BRUSHLESS TNi21

Dimensions (mm)

801495 - TNi21 + P52 with or without brake

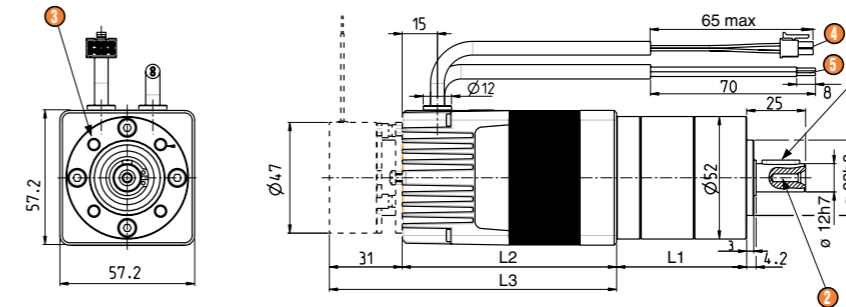

L1 1 stage: 55.3 ± 0.5
L1 2 stages: 69.5 ± 0.5
L1 3 stages: 83.7 ± 0.5

L2 80140: 92 max.

L3 80140: 123 max.

- 1 Parallel key 4 x 4 x 16 DIN 6885 A
- 2 M4 x 10
- 3 4 x M5 at 90°, depth 10 over Ø 40
- 4 Command cable 8 x AWG24 / 500 mm
- 5 Power cable 2 x AWG16 / 500 mm

801496 - 801896 - TNi21 + P62 with or without brake

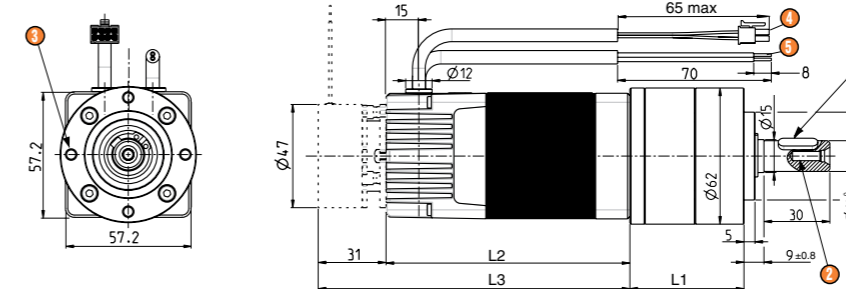

L1 1 stage: 52.1 ± 0.7
L1 2 stages: 67.9 ± 0.7
L1 3 stages: 83.8 ± 0.7

L2 80140: 92 max.

L2 80180: 112 max.

L3 80140: 123 max.

L3 80180: 143 max.

- 1 Parallel key 5 x 5 x 18 DIN 6885 A
- 2 M5 x 12
- 3 4 x M5 at 90°, depth 10 over Ø 52
- 4 Command cable 8 x AWG24 / 500 mm
- 5 Power cable 2 x AWG16 / 500 mm

801897 - 802897 - TNi21 + P81 with or without brake

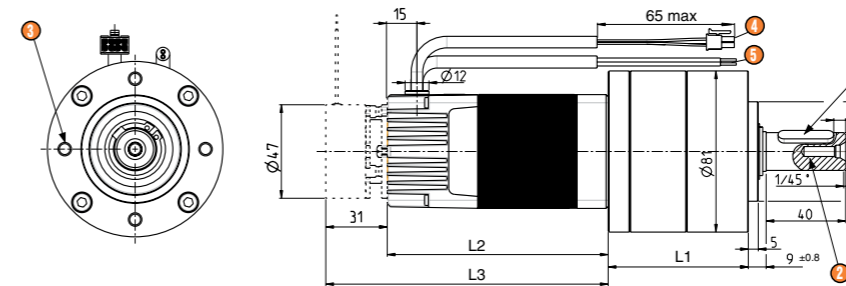

L1 1 stage: 70.5 ± 0.6
L1 2 stages: 92.2 ± 0.6
L1 3 stages: 113.8 ± 0.6

L2 80180-80280: 112 max.

L3 80180-80280: 143 max.

- 1 Parallel key 6 x 6 x 28 DIN 6885 A
- 2 M6 x 16
- 3 4 x M6 at 90°, depth 12 over Ø 65
- 4 Command cable 8 x AWG24 / 500 mm
- 5 Power cable 2 x AWG16 / 500 mm

801410 - 801810 - 802810 - TNi21 + RAD10 with or without brake

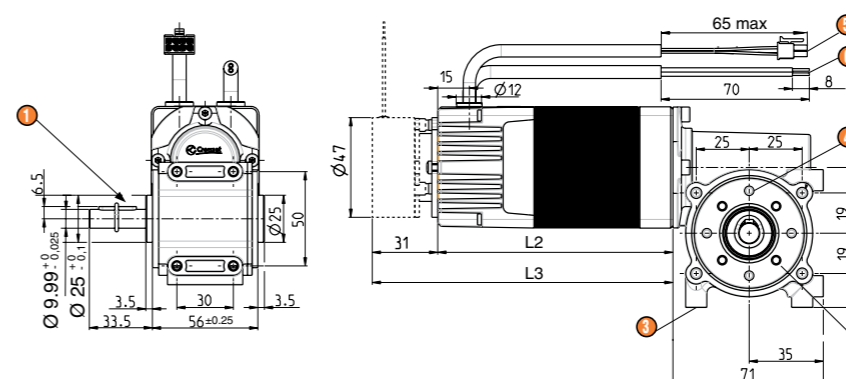

L2 80140: 92 max.
L2 80180-80280: 112 max.

L3 80140: 123 max.

L3 80180-80280: 143 max.

- 1 Parallele key 4 x 4 x 20 DIN 6885 A
- 2 4 x M4, depth 8 over Ø 36
- 3 8 x M5 depth 8
- 4 4 x Ø 3,8, depth 10 over Ø 40
- 5 Command cable 8 x AWG24 / 500 mm
- 6 Power cable 2 x AWG16 / 500 mm