

**Description**

The DZXRALTE-008L080 digital servo drive is designed to drive brushed and brushless servomotors from a compact form factor ideal for embedded applications. This fully digital drive operates in torque, velocity, or position mode and employs Space Vector Modulation (SVM), which results in higher bus voltage utilization and reduced heat dissipation compared to traditional PWM. The drive can be configured for a variety of external command signals. Commands can also be configured using the drive's built-in Motion Engine, an internal motion controller used with distributed motion applications. In addition to motor control, this drive features dedicated and programmable digital and analog inputs and outputs to enhance interfacing with external controllers and devices.

Network communication is accomplished using either RS-485/232 or Modbus RTU. This DZR Series drive features a single serial interface used for drive commissioning via DriveWare® 7, available for download at [www.a-m-c.com](http://www.a-m-c.com). The DZX Hardware Installation Manual is available for download from [www.a-m-c.com](http://www.a-m-c.com). All drive and motor parameters are stored in non-volatile memory.

The DZXRALTE-008L080 conforms to the following specifications and is designed to the Environmental Engineering Considerations as defined in MIL-STD-810F.

**Power Range**

Peak Current	8 A (5.7 A <sub>RMS</sub> )
Continuous Current	4 A (4 A <sub>RMS</sub> )
Supply Voltage	10 - 80 VDC

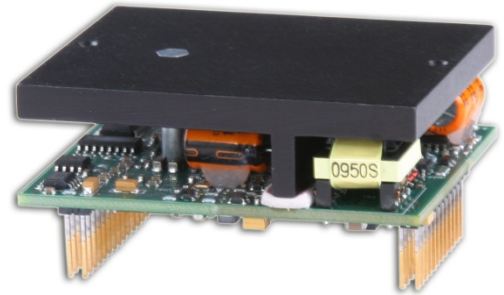

Extended Environment Performance	
Ambient Temperature	-40°C to +75°C (-40°F to +167°F)
Storage Temperature	-50°C to +100°C (-58°F to +212°F)
Thermal Shock	-40°C to +75°C (-40°F to +167°F) in 2 min.
Relative Humidity	0 to 95% Non-Condensing
Vibration	30 Grms for 5 min. in 3 axes

**Features**

- ▲ Four Quadrant Regenerative Operation
- ▲ Space Vector Modulation (SVM) Technology
- ▲ Fully Digital State-of-the-art Design
- ▲ Programmable Gain Settings
- ▲ Fully Configurable Current, Voltage, Velocity and Position Limits
- ▲ PIDF Velocity Loop
- ▲ PID + FF Position Loop
- ▲ Compact Size, High Power Density
- ▲ 12-bit Analog to Digital Hardware
- ▲ On-the-Fly Mode Switching
- ▲ On-the-Fly Gain Set Switching

**MODES OF OPERATION**

- Current
- Hall Velocity
- Position
- Velocity

**COMMAND SOURCE**

- PWM and Direction
- Encoder Following
- Over the Network
- ±10 V Analog
- 5V Step and Direction
- Sequencing
- Indexing
- Jogging

**FEEDBACK SUPPORTED**

- Halls
- Incremental Encoder
- ±10 VDC Position
- Auxiliary Incremental Encoder

**INPUTS/OUTPUTS**

- 3 High Speed Captures
- 1 Programmable Analog Input (12-bit Resolution)
- 2 Programmable Digital Inputs (Differential)
- 3 Programmable Digital Inputs (Single-Ended)
- 3 Programmable Digital Outputs (Single-Ended)



**AGENCY APPROVALS & COMPLIANCE CONSIDERATIONS**

- RoHS
- MIL-STD-810F (as stated)
- MIL-STD-1275D (optional)
- MIL-STD-461E (optional)
- MIL-STD-704F (optional)
- MIL-HDBK-217 (optional)
- UL
- cUL
- CE Class A (LVD)
- CE Class A (EMC)

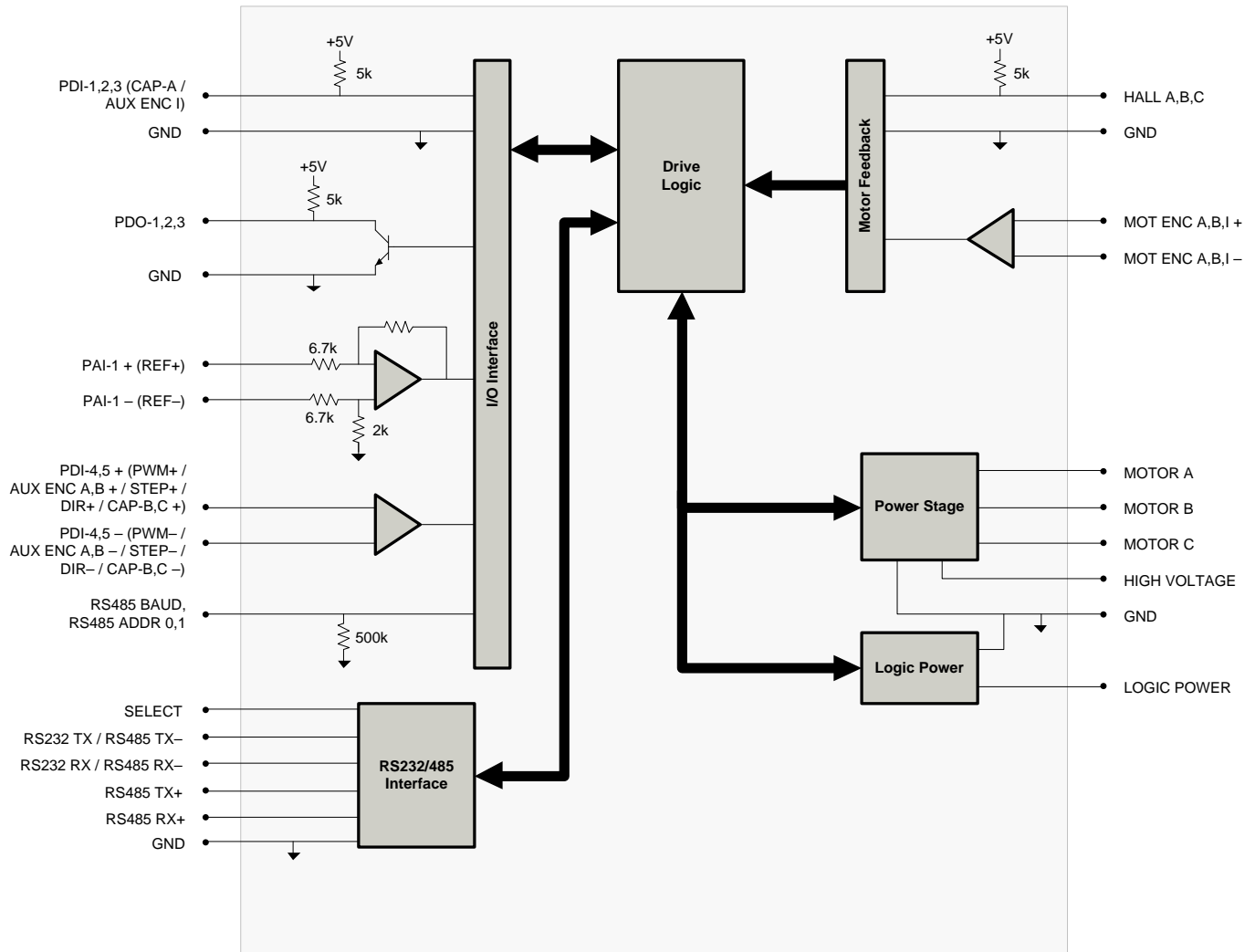
**BLOCK DIAGRAM**



**Information on Approvals and Compliances**

MIL-STD-810F	Environmental Engineering Considerations and Laboratory Tests – (as stated)
MIL-STD-1275D	Characteristics of 28 Volt DC Electrical Systems in Military Vehicles – (optional)
MIL-STD-461E	Requirements for the Control of Electromagnetic Interference Characteristics of Subsystems and Equipment – (optional)
MIL-STD-704F	Aircraft Electric Power Characteristics – (optional)
MIL-HDBK-217	Reliability Prediction of Electronic Equipment (MTBF) – (optional)
	US and Canadian safety compliance with UL 508c, the industrial standard for power conversion electronics. UL registered under file number E140173. Note that machine components compliant with UL are considered UL registered as opposed to UL listed as would be the case for commercial products.
	Compliant with European EMC Directive 2004/108/EC on Electromagnetic Compatibility (specifically EN 61000-6-4:2007 for Emissions, Class A and EN 61000-6-2:2005 for Immunity, Performance Criteria A). LVD requirements of Directive 2006/95/EC (specifically, EN 60204-1:2004, a Low Voltage Directive to protect users from electrical shock).
	RoHS (Reduction of Hazardous Substances) is intended to prevent hazardous substances such as lead from being manufactured in electrical and electronic equipment.

**SPECIFICATIONS**

Description		Power Specifications		Value	
Description		Units	Value		
DC Supply Voltage Range		VDC	10 - 80		
DC Bus Over Voltage Limit		VDC	88		
DC Bus Under Voltage Limit		VDC	8		
Logic Supply Voltage		VDC	5 (+/- 5%)		
Maximum Peak Output Current <sup>1</sup>		A (Arms)	8 (5.7)		
Maximum Continuous Output Current		A (Arms)	4 (4)		
Maximum Continuous Output Power		W	304		
Maximum Power Dissipation at Continuous Current <sup>2</sup>		W	16		
Internal Bus Capacitance <sup>3</sup>		µF	20		
Minimum Load Inductance (Line-To-Line) <sup>4</sup>		µH	250		
Switching Frequency		kHz	20		
Maximum Output PWM Duty Cycle		%	92		
Description		Units	Control Specifications		Value
Communication Interfaces		-	RS-485/232 / Modbus RTU		
Command Sources		-	±10 V Analog, 5V Step and Direction, Encoder Following, Over the Network, PWM and Direction, Sequencing, Indexing, Jogging		
Feedback Supported		-	±10 VDC Position, Auxiliary Incremental Encoder, Halls, Incremental Encoder		
Commutation Methods		-	Sinusoidal, Trapezoidal		
Modes of Operation		-	Current, Hall Velocity, Position, Velocity		
Motors Supported		-	Closed Loop Vector, Single Phase (Brushed, Voice Coil, Inductive Load), Three Phase (Brushless)		
Hardware Protection		-	40+ Configurable Functions, Over Current, Over Temperature (Drive & Motor), Over Voltage, Short Circuit (Phase-Phase & Phase-Ground), Under Voltage		
Programmable Digital Inputs/Outputs (PDIs/PDOs)		-	5/3		
Programmable Analog Inputs/Outputs (PAIs/PAOs)		-	1/0		
Primary I/O Logic Level		-	5V TTL		
Current Loop Sample Time		µs	50		
Velocity Loop Sample Time		µs	100		
Position Loop Sample Time		µs	100		
Maximum Encoder Frequency		MHz	20 (5 pre-quadrature)		
Description		Units	Mechanical Specifications		Value
Agency Approvals		-	RoHS, MIL-STD-810F (as stated), MIL-STD-1275D (optional), MIL-STD-461E (optional), MIL-STD-704F (optional), MIL-HDBK-217 (optional), UL, cUL, CE Class A (LVD), CE Class A (EMC)		
Size (H x W x D)		mm (in)	63.5 x 50.8 x 22.9 (2.5 x 2 x 0.9)		
Weight		g (oz)	105 (3.7)		
Baseplate Operating Temperature Range <sup>5</sup>		°C (°F)	-40 - 85 (-40 - 185)		
Ambient Temperature Range		°C (°F)	-40 - 75 (-40 - 167)		
Storage Temperature Range		°C (°F)	-50 - 100 (-58 - 212)		
Thermal Shock		°C (°F)	-40 - 75 (-40 - 167) in 2 minutes		
Vibration		Grms	30 for 5 minutes in 3 axes		
Relative Humidity		-	0 - 95% Non-Condensing		
Cooling System		-	Natural Convection		
Form Factor		-	PCB Mounted		
P1 Connector		-	30-pin, 2.54 mm spaced, dual-row header		
P2 Connector		-	24-pin, 2.54 mm spaced, dual-row header		

**Notes**

1. Capable of supplying drive rated peak current for 2 seconds with 10 second foldback to continuous value. Longer times are possible with lower current limits.
2. Continuous  $A_{rms}$  value attainable when RMS Charge-Based Limiting is used.
3. It is recommended to connect a 100µF / 100V electrolytic capacitor between High Voltage and Power Ground.
4. Lower inductance is acceptable for bus voltages well below maximum. Use external inductance to meet requirements.
5. Additional cooling and/or heatsink may be required to achieve rated performance.

**PIN FUNCTIONS**

P1 - Signal Connector				
Pin	Name	Description / Notes	I/O	
1	RS485 ADDR 0	RS-485 Network Address Selector	I	
2	RS485 ADDR 1		I	
3	PAI-1 + (REF+)	Differential Programmable Analog Input or Reference Signal Input (12-bit Resolution)	I	
4	PAI-1 - (REF-)		I	
5	GND	Ground	GND	
6	RS485 BAUD	RS-485 Baud Rate Selector	I	
7	PDO-1	Programmable Digital Output	O	
8	PDO-2	Programmable Digital Output	O	
9	PDO-3	Programmable Digital Output	O	
10	PDI-1	Programmable Digital Input	I	
11	PDI-2	Programmable Digital Input	I	
12	PDI-3 (CAP-A / AUX ENC I)	Programmable Digital Input or High Speed Capture or Auxiliary Encoder Index	I	
13	RS232 RX / RS485 RX-	Receive Line (RS-232 or RS-485)	I	
14	RS485 RX+	Receive Line (RS-485)	I	
15	RS232 TX / RS485 TX-	Transmit Line (RS-232 or RS-485)	O	
16	RS485 TX+	Transmit Line (RS-485)	O	
17	PDI-4 + (PWM+ / STEP+ / AUX ENC A+ / CAP-B+)	Programmable Digital Input or PWM or Step+ or Auxiliary Encoder or High Speed Capture (For Single-Ended Signals see DZ HW Installation Manual)	I	
18	PDI-4 - (PWM- / STEP- / AUX ENC A- / CAP-B-)		I	
19	PDI-5 + (DIR+ / AUX ENC B+ / CAP-C+)	Programmable Digital Input or Direction or Auxiliary Encoder or High Speed Capture (For Single-Ended Signals see DZ HW Installation Manual)	I	
20	PDI-5 - (DIR- / AUX ENC B- / CAP-C-)		I	
21	GND	Ground	GND	
22	HALL A	Single-ended Commutation Sensor Input (For Differential Inputs See MC1XDZ02 Datasheet For Recommended Signal Conditioning)	I	
23	HALL B		I	
24	HALL C		I	
25	MOT ENC I+	Differential Encoder Index Input (See MC1XDZ02 Datasheet For Recommended Signal Conditioning)	I	
26	MOT ENC I-		I	
27	MOT ENC A+	Differential Encoder A Channel Input (See MC1XDZ02 Datasheet For Recommended Signal Conditioning)	I	
28	MOT ENC A-		I	
29	MOT ENC B+	Differential Encoder B Channel Input (See MC1XDZ02 Datasheet For Recommended Signal Conditioning)	I	
30	MOT ENC B-		I	

P2 - Power Connector				
Pin	Name	Description / Notes	I/O	
1a	LOGIC PWR	Logic Supply Input	I	
1b	RESERVED	Reserved	-	
2a	2b	GND	GND	
3a	3b	GND	GND	
4a	4b	DC Power Input. 3A Continuous Current Rating Per Pin. 100µF, 100V external capacitor recommended between High Voltage and Ground.	I	
5a	5b		I	
6a	6b	Reserved	-	
7a	7b	Motor Phase Outputs. Current output distributed equally across 4 pins per motor phase, 3A continuous current carrying capacity per pin.	O	
8a	8b		O	
9a	9b		O	
10a	10b		O	
11a	11b		O	
12a	12b		O	
11a	11b		O	
12a	12b		O	

**Pin Details**
**RS485 ADDR 0 (P1-1)**

This pin, RS485 ADDR 0, as well as RS485 ADDR 1, are used for RS-485 network addressing. To set the address of a drive, use the formula

$$RS485Address = \frac{7 * Addr0}{3} + 8 * \frac{7 * Addr1}{3}$$

where *RS485Address* is the desired node address and *Addr0* and *Addr1* represent the voltage that should be applied to pins RS485 ADDR 0 and RS485 ADDR 1, respectively. The values for *Addr0* and *Addr1* are always integer multiples of 3/7 V within the range 0-3 V. Examples of the voltages required to set certain node addresses are given in the table below. Note that setting a drive address of 0 will utilize the address stored in non-volatile memory.

RS485 ADDR 0 Value (V)	RS485 ADDR 1 Value (V)	RS485 ADDR Tolerance (V)	RS485 Address (Address #)
0	0	±0.1	Address stored in non-volatile memory
3/7 (0.43)	0	±0.1	1
6/7 (0.86)	0	±0.1	2
9/7 (1.3)	0	±0.1	3
...	...	±0.1	...
18/7 (2.57)	21/7 (3.0)	±0.1	62
21/7 (3.0)	21/7 (3.0)	±0.1	63

#### RS485 BAUD (P1-6)

The RS-485 baud rate is set by applying the appropriate voltage to the RS485 BAUD pin as given in the table below.

RS485 BAUD Value (V)	RS485 BAUD Tolerance (V)	RS485 Baud Rate (bits/s)
0	±0.388	Bit rate stored in non-volatile memory
1	±0.388	9.6k
2	±0.388	38.4k
3	±0.388	115.2k

## HARDWARE SETTINGS

### Jumper Settings

Jumper	Description	Configuration		
		Not Installed	Pins 1-2	Pins 2-3
J1	Reserved.	-	-	N/A
J2	Reserved.	-	-	N/A
J3	RS-485 selection. Install this jumper (2mm) to select RS-485 communication. This jumper is located on a 6-pin header between the PCB and heatsink. It consists of the two pins closest to the corner of the PCB.	RS-232	RS-485	N/A

**MECHANICAL INFORMATION**

**P1 - Signal Connector**

Connector Information		30-pin, 2.54 mm spaced, dual-row header
Mating Connector	Details	Samtec: SSM-115-L-DV
	Included with Drive	No

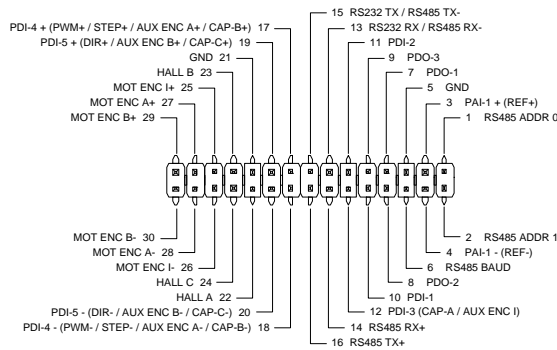

**P2 - Power Connector**

Connector Information		24-pin, 2.54 mm spaced, dual-row header
Mating Connector	Details	Samtec: BCS-112-L-D-PE
	Included with Drive	No

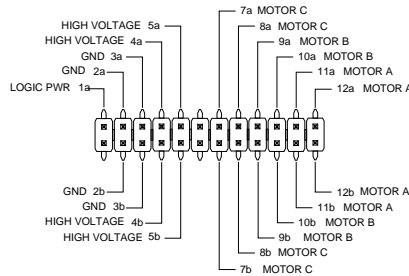

**MOUNTING DIMENSIONS**

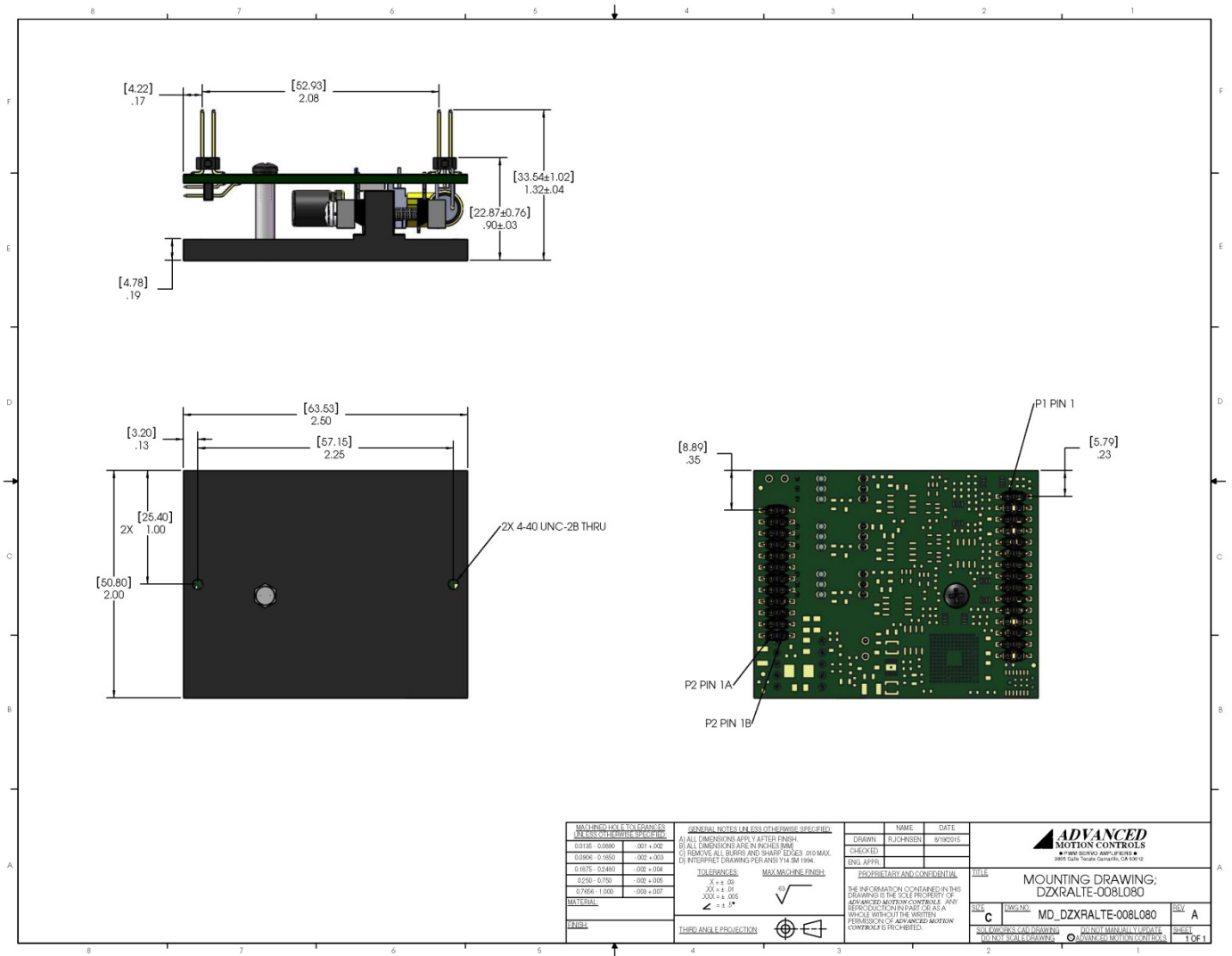

**PART NUMBERING INFORMATION**

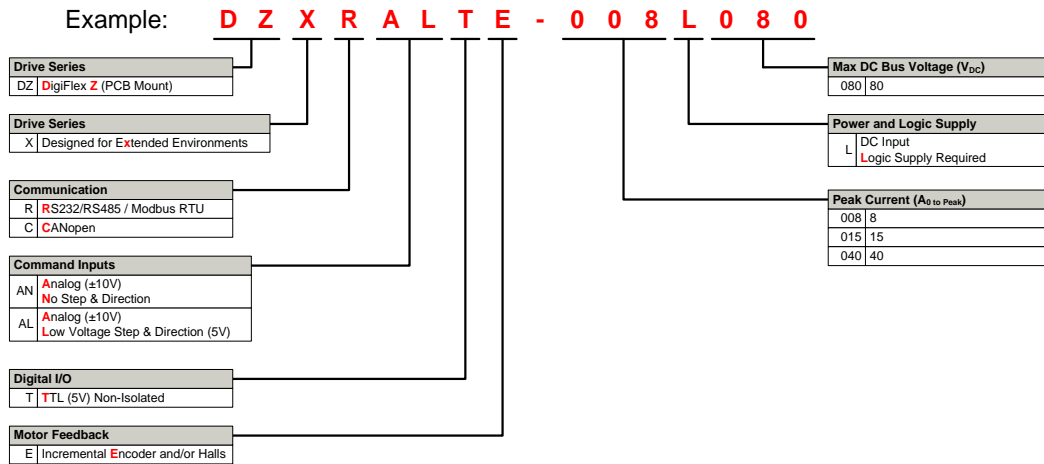

DigiFlex® Performance™ series of products are available in many configurations. Note that not all possible part number combinations are offered as standard drives. All models listed in the selection tables of the website are readily available, standard product offerings.

ADVANCED Motion Controls also has the capability to promptly develop and deliver specified products for OEMs with volume requests. Our Applications and Engineering Departments will work closely with your design team through all stages of development in order to provide the best servo drive solution for your system. Equipped with on-site manufacturing for quick-turn customs capabilities, ADVANCED Motion Controls utilizes our years of engineering and manufacturing expertise to decrease your costs and time-to-market while increasing system quality and reliability.

**Examples of Customized Products**

- ▲ Optimized Footprint
  - ▲ Private Label Software
  - ▲ OEM Specified Connectors
  - ▲ No Outer Case
  - ▲ Increased Current Resolution
  - ▲ Increased Temperature Range
  - ▲ Custom Control Interface
  - ▲ Integrated System I/O
- ▲ Tailored Project File
  - ▲ Silkscreen Branding
  - ▲ Optimized Base Plate
  - ▲ Increased Current Limits
  - ▲ Increased Voltage Range
  - ▲ Conformal Coating
  - ▲ Multi-Axis Configurations
  - ▲ Reduced Profile Size and Weight

Feel free to contact Applications Engineering for further information and details.

**Available Accessories**

ADVANCED Motion Controls offers a variety of accessories designed to facilitate drive integration into a servo system. Visit [www.a-m-c.com](http://www.a-m-c.com) to see which accessories will assist with your application design and implementation.

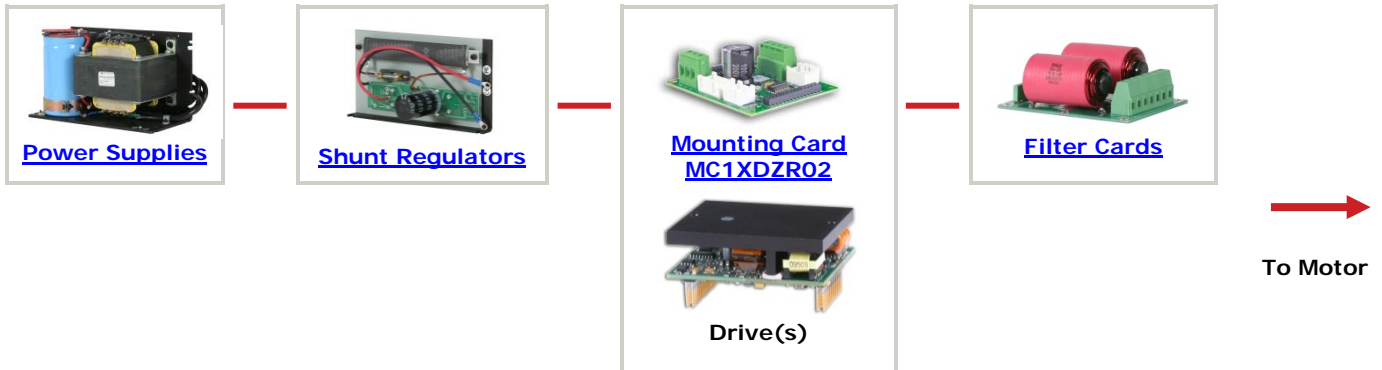

All specifications in this document are subject to change without written notice. Actual product may differ from pictures provided in this document.