

**Description**

The AZBE40A8 PWM servo drive is designed to drive brushless and brushed DC motors at a high switching frequency. To increase system reliability and to reduce cabling costs, the drive is designed for direct integration into your PCB. The AZBE40A8 is fully protected against over-voltage, under-voltage, over-current, over-heating, invalid commutation, and short-circuits. A single digital output indicates operating status. The drive interfaces with digital controllers that have analog  $\pm 10V$  output. The AZBE40A8 can utilize either quadrature encoder inputs or Tachometer feedback for velocity control. This servo drive requires only a single unregulated isolated DC power supply, and is fully RoHS (Reduction of Hazardous Substances) compliant.

See Part Numbering Information on last page of datasheet for additional ordering options.

**Power Range**

Peak Current	40 A
Continuous Current	20 A
Supply Voltage	10 - 80 VDC

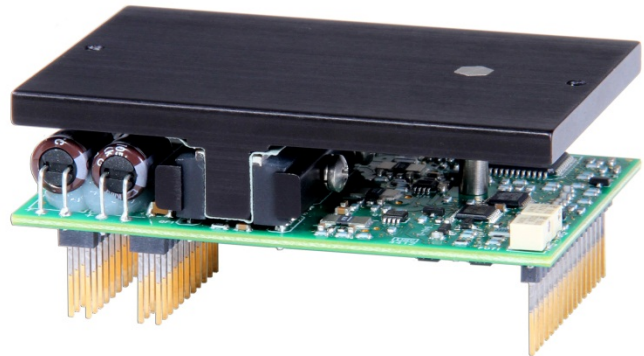

**Features**

- ▲ Four Quadrant Regenerative Operation
- ▲ Direct Board-to-Board Integration
- ▲ Lightweight
- ▲ High Switching Frequency
- ▲ High Performance Thermal Dissipation
- ▲ Differential Input Command
- ▲ Digital Fault Output Monitor
- ▲ 12VDC Operation
- ▲ Encoder Velocity Mode
- ▲ Current Monitor Output
- ▲ Compact Size
- ▲ High Power Density

**HARDWARE PROTECTION**

- Under-Voltage
- Over-Voltage
- Over-Current
- Over-Temperature
- Short-circuit (phase-phase)
- Short-circuit (phase-ground)

**INPUTS/OUTPUTS**

- Digital Fault Output
- Digital Inhibit Input
- Analog Current Monitor
- Analog Command Input
- Analog Current Reference

**COMMUTATION**

- Trapezoidal

**FEEDBACK SUPPORTED**

- Encoder
- Hall Sensors
- Tachometer ( $\pm 60$  VDC)

**MODES OF OPERATION**

- Current
- Duty Cycle (Open Loop)
- Encoder Velocity
- Tachometer Velocity

**MOTORS SUPPORTED**

- Three Phase (Brushless)
- Single Phase (Brushed, Voice Coil, Inductive Load)

**COMMAND SOURCE**

- $\pm 10$  V Analog



**COMPLIANCES & AGENCY APPROVALS**

- UL
- cUL
- CE Class A (LVD)
- CE Class A (EMC)
- RoHS

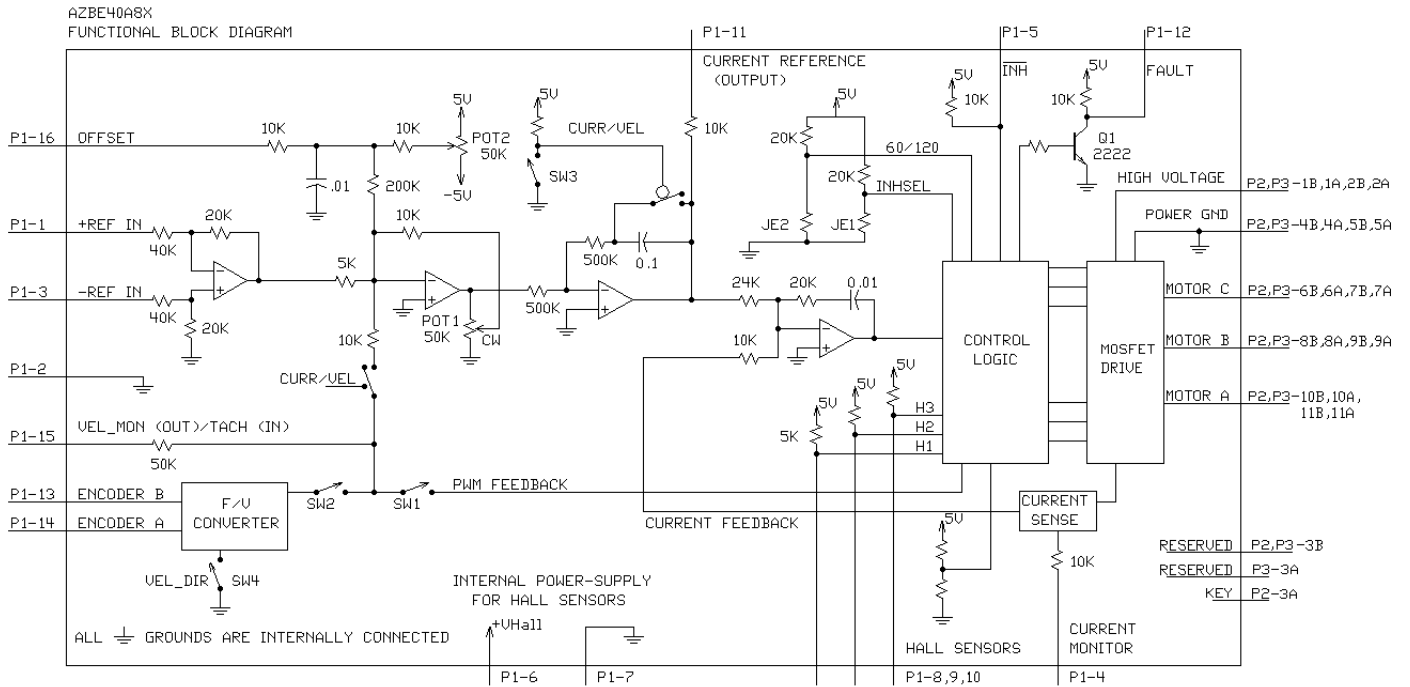
**BLOCK DIAGRAM**



**Information on Approvals and Compliances**

	<p>US and Canadian safety compliance with UL 508c, the industrial standard for power conversion electronics. UL registered under file number E140173. Note that machine components compliant with UL are considered UL registered as opposed to UL listed as would be the case for commercial products.</p>
	<p>Compliant with European EMC Directive 2004/108/EC on Electromagnetic Compatibility (specifically EN 61000-6-4:2007 for Emissions, Class A and EN 61000-6-2:2005 for Immunity, Performance Criteria A). LVD requirements of Directive 2006/95/EC (specifically, EN 60204-1:2004, a Low Voltage Directive to protect users from electrical shock).</p>
	<p>RoHS (Reduction of Hazardous Substances) is intended to prevent hazardous substances such as lead from being manufactured in electrical and electronic equipment.</p>

**SPECIFICATIONS**

Power Specifications		
Description	Units	Value
DC Supply Voltage Range	VDC	10 - 80
DC Bus Over Voltage Limit	VDC	88
DC Bus Under Voltage Limit	VDC	9
Maximum Peak Output Current <sup>1</sup>	A	40
Maximum Continuous Output Current	A	20
Maximum Continuous Output Power	W	1520
Maximum Power Dissipation at Continuous Current	W	80
Minimum Load Inductance (Line-To-Line) <sup>2</sup>	μH	100
Internal Bus Capacitance <sup>3</sup>	μF	141
Low Voltage Supply Outputs	-	+6 VDC (30 mA)
Switching Frequency	kHz	33

Control Specifications		
Description	Units	Value
Command Sources	-	±10 V Analog
Feedback Supported	-	Halls, Incremental Encoder, Tachometer (± 60 VDC)
Commutation Methods	-	Trapezoidal
Modes of Operation	-	Current, Encoder Velocity, Duty Cycle, Tachometer Velocity
Motors Supported	-	Three Phase (Brushless), Single Phase (Brushed, Voice Coil, Inductive Load)
Hardware Protection	-	Invalid Commutation Feedback, Over Current, Over Temperature, Over Voltage, Under Voltage, Short Circuit (Phase-Phase & Phase-Ground)

Mechanical Specifications		
Description	Units	Value
Agency Approvals	-	CE Class A (EMC), CE Class A (LVD), cUL, RoHS, UL
Size (H x W x D)	mm (in)	76.2 x 50.8 x 22.9 (3 x 2 x 0.9)
Weight	g (oz)	120 (4.23)
Heatsink (Base) Temperature Range <sup>4</sup>	°C (°F)	0 - 75 (32 - 167)
Storage Temperature Range	°C (°F)	-40 - 85 (-40 - 185)
Form Factor	-	PCB Mounted
P1 Connector	-	16-pin, 2.54 mm spaced header
P2 Connector	-	22-pin, 2.54 mm spaced, dual-row header
P3 Connector	-	22-pin, 2.54 mm spaced, dual-row header

**Notes**

1. Maximum duration of peak current is ~2 seconds. Peak RMS value must not exceed continuous current rating of the drive.
2. Lower inductance is acceptable for bus voltages well below maximum. Use external inductance to meet requirements.
3. Requires a 470μF/100V electrolytic capacitor near the P2 Power Connector between High Voltage and Power Ground pins.
4. Additional cooling and/or heatsink may be required to achieve rated performance.

**PIN FUNCTIONS**

P1 - Signal Connector			
Pin	Name	Description / Notes	I/O
1	+REF IN	Differential Reference Input ( $\pm 10$ V Operating Range, $\pm 15$ V Maximum Input)	I
2	SIGNAL GND	Signal Ground	GND
3	-REF IN	Differential Reference Input ( $\pm 10$ V Operating Range, $\pm 15$ V Maximum Input)	I
4	CURRENT MONITOR	Current Monitor. Analog output signal proportional to the actual current output. Scaling is 13.3 A/V. Measure relative to signal ground.	O
5	INHIBIT IN	TTL level (+5 V) inhibit/enable input. Leave open to enable drive. Pull to ground to inhibit drive. Inhibit turns off all power devices.	I
6	+V HALL OUT	Low Power Supply For Hall Sensors (+6 V @ 30 mA). Referenced to signal ground. Short circuit protected.	O
7	SIGNAL GND	Signal Ground	GND
8	HALL 1	Single-ended Hall/Commutation Sensor Inputs (+5 V logic level)	I
9	HALL 2*		I
10	HALL 3		I
11	CURRENT REFERENCE	Measures the command signal to the internal current-loop. This pin has a maximum output of $\pm 7.3$ V when the drive outputs maximum peak current. Measure relative to signal ground.	O
12	FAULT OUT	TTL level (+5 V) output becomes high when power devices are disabled due to at least one of the following conditions: inhibit, invalid Hall state, output short circuit, over voltage, over temperature, power-up reset.	O
13	ENCODER-B IN	Single-ended encoder channel B input. +5 V logic level.	I
14	ENCODER-A IN	Single-ended encoder channel A input. +5 V logic level.	I
15	VEL MONITOR OUT / TACH IN	Velocity Monitor ( $\pm 10$ V range). Analog output proportional to motor speed. In Encoder Velocity mode, output is proportional to the encoder line frequency. Encoder Velocity scaling is 22 kHz/V. For Tachometer Velocity mode, feedback voltage range is $\pm 60$ VDC max.	O/I
16	OFFSET	Connection to external resistance for command offset adjustments. Apply a $\pm$ VDC (10V Max) signal through an external potentiometer into this pin to offset the input gain.	I

P2 and P3 - Power Connector			
Pin	Name	Description / Notes	I/O
1b	1a	DC Power Input. 3A Continuous Current Rating Per Pin. Requires at least 470 $\mu$ F / 100 V external electrolytic capacitor connected as close as possible to pins between High Voltage and Power Ground.	I
2b	2a		I
3b		Not Connected (Reserved) Key: No Connection (pin removed) for P2. Not Connected (Reserved) for P3.	-
	3a		-
4b	4a	Power Ground (Common With Signal Ground). 3A Continuous Current Rating Per Pin	GND
5b	5a		GND
6b	6a	Motor Phase Outputs. Current output distributed equally across both P2 and P3 connectors – 8 pins per motor phase, 3A continuous current carrying capacity per pin.	O
7b	7a		O
8b	8a		O
9b	9a		O
10b	10a		O
11b	11a		O

\*For use with Single Phase (Brushed) motors, ground Hall 2 and only connect motor leads to Motor A and Motor B.

## HARDWARE SETTINGS

### Switch Functions

The DIP Switch bank is located on the underside of the drive PCB. The ON setting is labeled on the switch housing. Setting switches towards the P2 Power Connector is the ON position. Setting switches towards the P1 Signal Connector is the OFF position. The tables below describe switch functionality.

Switch	Description	Setting	
		On	Off
1	Duty Cycle mode selector. Activates internal PWM feedback.	Duty Cycle mode	Other modes
2	Activate velocity feedback or monitor. For Encoder Velocity mode, activates feedback. For Current mode, activates velocity monitor.	Active	Inactive
3	Current mode selector.	Current mode	Other modes
4	Velocity feedback polarity. Changes the polarity of the internal feedback signal and the velocity monitor output signal. Inversion of the feedback polarity may be required to prevent a motor run-away condition.	Standard	Inverted

### Mode Selection Table

	SW1	SW2	SW3
CURRENT	OFF	ON/OFF	ON
DUTY CYCLE	ON	OFF	OFF
ENCODER VELOCITY*	OFF	ON	OFF
TACHOMETER VELOCITY	OFF	OFF	OFF

\*NOTE: See details of switch 4 for further Encoder Velocity configuration information.

### Jumper Settings

Jumpers are SMT, 0 ohm resistors located on the underside of the drive PCB. By default, the drive is configured with the jumpers installed. Typical drive operation will not require the jumpers to be removed. Please contact the factory before jumper removal.

Jumper	Description	Configuration	
		Not Installed	Installed
JE1	Inhibit logic. Sets the logic level of inhibit pins. Labeled JE1 on the PCB of the drive.	Low Enable	Low Inhibit
JE2	Hall sensor phasing. Selects 120 or 60 degree commutation phasing. Labeled JE2 on the PCB of the drive.	60 degree	120 degree

### Potentiometer Functions

Potentiometers are located between the PCB and the drive baseplate, and are accessible from the side. Potentiometers are approximately linear and have 12 active turns with 1 inactive turn on each end.

Potentiometer	Description	Turning CW
1	Loop gain adjustment for duty cycle / velocity modes. Turn this pot fully CCW in current mode. Located closest to the corner of the PCB.	Increases gain
2	Offset. Used to adjust any imbalance in the input signal or in the amplifier. Located furthest from the corner of the PCB.	Adjusts offset in negative direction

**MECHANICAL INFORMATION**

**P1 - Signal Connector**

Connector Information	16-pin, 2.54 mm spaced header	
Mating Connector	Details	Samtec: BCS-116-L-S-PE
	Included with Drive	No

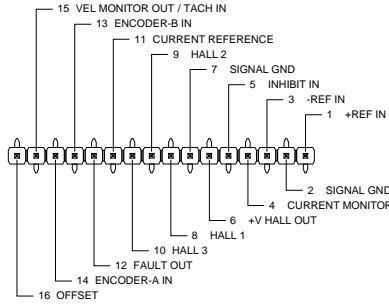

**P2 - Power Connector**

Connector Information	22-pin, 2.54 mm spaced, dual-row header	
Mating Connector	Details	Samtec: BCS-111-L-D-PE
	Included with Drive	No

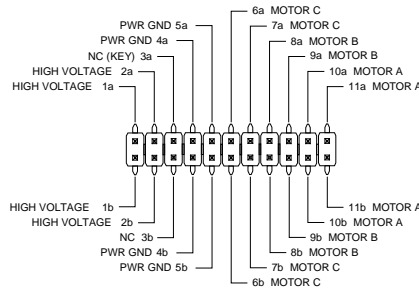

**P3 - Power Connector**

Connector Information	22-pin, 2.54 mm spaced, dual-row header	
Mating Connector	Details	Samtec: BCS-111-L-D-PE
	Included with Drive	No

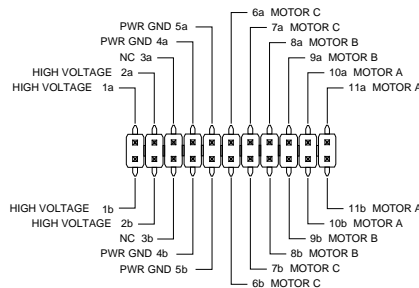

**MOUNTING DIMENSIONS**

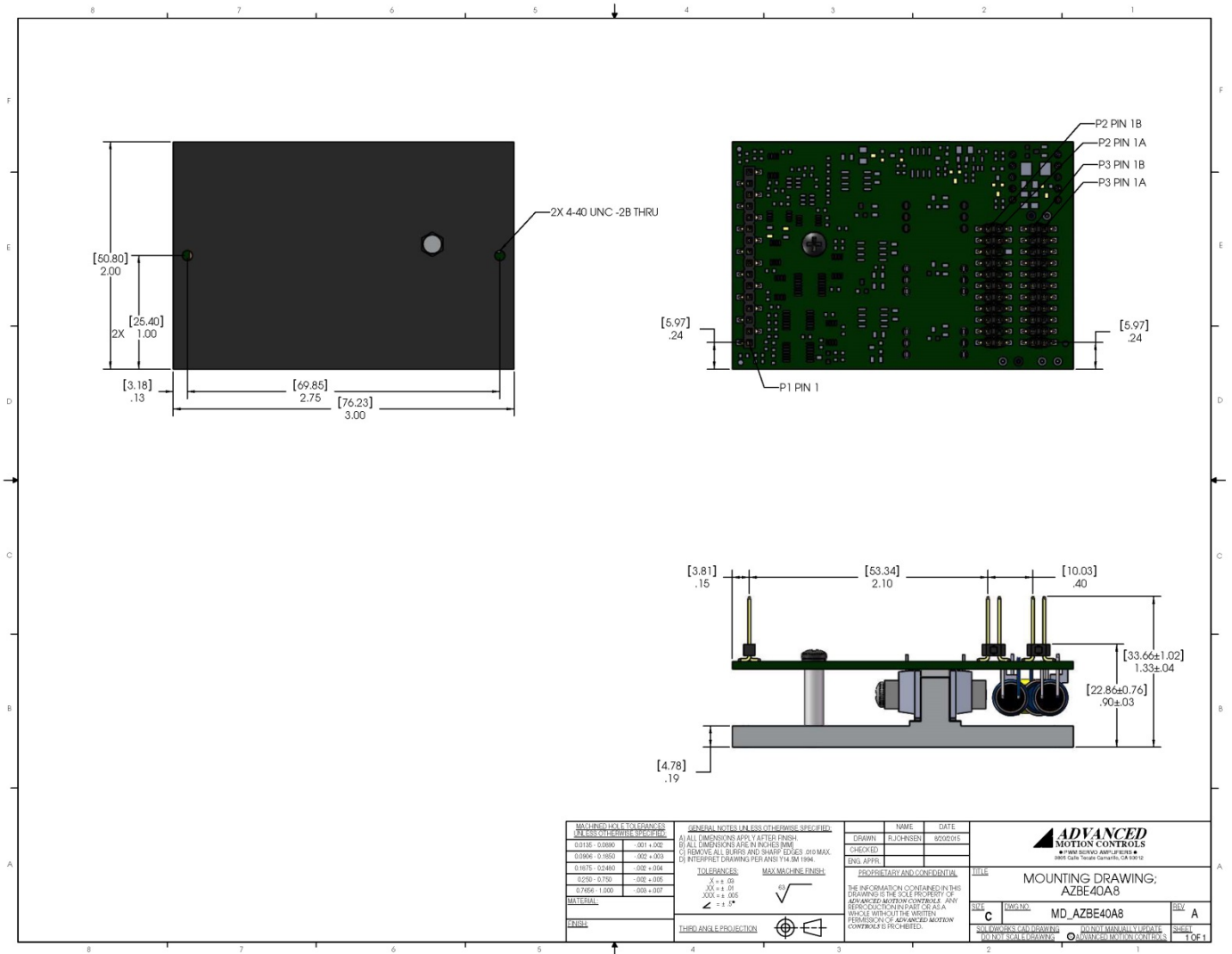

**PART NUMBERING INFORMATION**

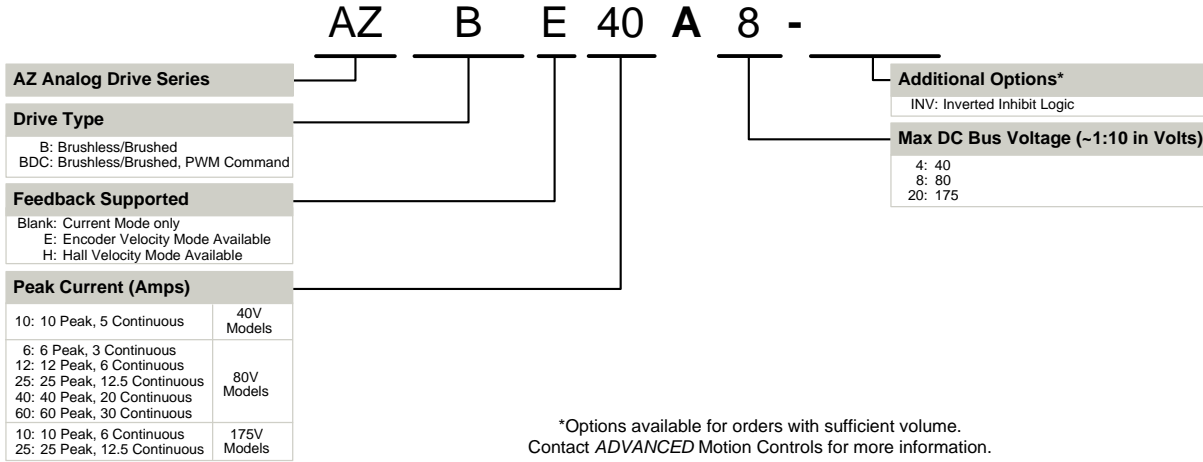

ADVANCED Motion Controls AZ series of servo drives are available in many configurations. Note that not all possible part number combinations are offered as standard drives. All models listed in the selection tables of the website are readily available, standard product offerings.

ADVANCED Motion Controls also has the capability to promptly develop and deliver specified products for OEMs with volume requests. Our Applications and Engineering Departments will work closely with your design team through all stages of development in order to provide the best servo drive solution for your system. Equipped with on-site manufacturing for quick-turn customs capabilities, ADVANCED Motion Controls utilizes our years of engineering and manufacturing expertise to decrease your costs and time-to-market while increasing system quality and reliability.

**Examples of Modifications and Customized Products**

- |   |  |
|---|--|
| <ul style="list-style-type: none"> <li>▲ Integration of Drive into Motor Housing</li> <li>▲ Mount OEM PCB onto Drive Without Cables</li> <li>▲ Multi-axis Configuration for Compact System</li> <li>▲ Custom PCB and Baseplate for Optimized Footprint</li> <li>▲ RTV/Epoxy Components for High Vibration</li> <li>▲ OEM Specified Connectors for Instant Compatibility</li> <li>▲ OEM Specified Silkscreen for Custom Appearance</li> <li>▲ Increased Thermal Limits for High Temp. Operation</li> </ul> | <ul style="list-style-type: none"> <li>▲ Integrate OEM Circuitry onto Drive PCB</li> <li>▲ Custom Control Loop Tuned to Motor Characteristics</li> <li>▲ Custom I/O Interface for System Compatibility</li> <li>▲ Preset Switches and Pots to Reduce User Setup</li> <li>▲ Optimized Switching Frequency</li> <li>▲ Ramped Velocity Command for Smooth Acceleration</li> <li>▲ Remove Unused Features to Reduce OEM Cost</li> <li>▲ Application Specific Current and Voltage Limits</li> </ul> |
|---|--|

Feel free to contact Applications Engineering for further information and details.

**Available Accessories**

ADVANCED Motion Controls offers a variety of accessories designed to facilitate drive integration into a servo system. Visit [www.a-m-c.com](http://www.a-m-c.com) to see which accessories will assist with your application design and implementation.

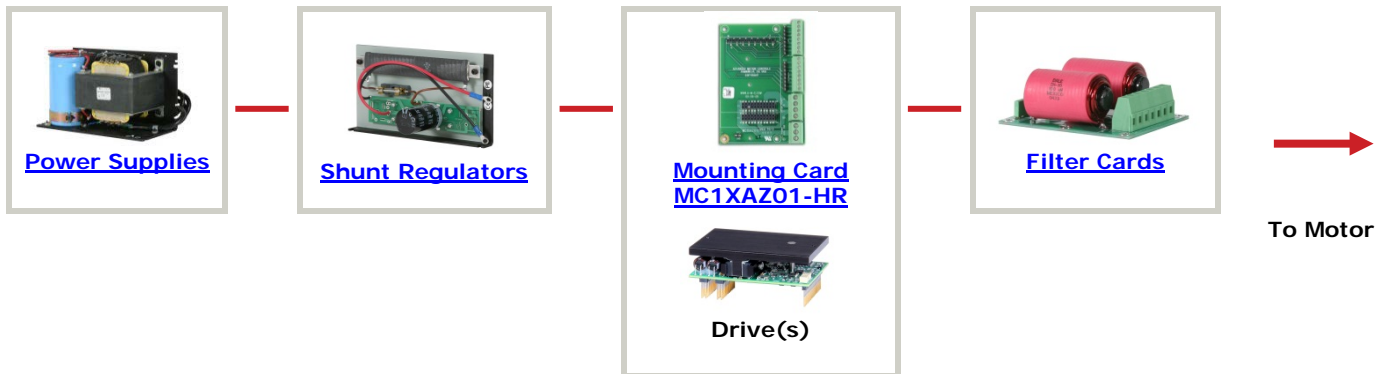

All specifications in this document are subject to change without written notice. Actual product may differ from pictures provided in this document.